

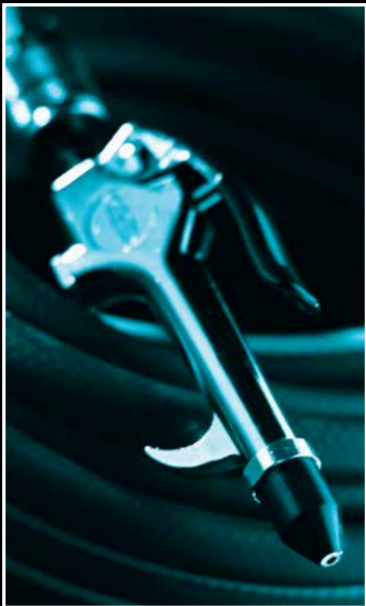

2018

INNOVATION

• *Taking the work out of work.™*





the makers of:

FLEXZILLA®

PREMIUM HOSES, TOOLS & EQUIPMENT

flexzilla.com

SMARTFLEX®

Quality & Value

ColorConnex®

Color Code System for Standard Interchanges

LOCK-N-LOAD™

THREADLESS BARREL GREASE GUNS

Workforce®

COLORS™



Mission:

To create innovative products that customers are passionate about.

Vision:

Legacy Manufacturing creates leading global brands that consistently surpass customer expectations for performance and job satisfaction. We challenge convention, embrace experimentation and applaud innovation. Legacy constantly seeks ways to make our products better.

Taking the work out of work.™

6 Hose Reels

Levelwind™ Retractable Hose Reels	7-8	Workforce Manual Open Face Air Hose Reels - Fixed	11
Lead-in Hoses and Mounting Brackets - Levelwind Reels.	9	Workforce Manual Open Face Air Hose Reels.	12
Workforce® Retractable Open Face Hose Reels - Single Axle Arm	10		

13 Hoses

SmartFlex® Air Hose Assemblies	14	Workforce PVC Whip Hose Assemblies	16
SmartFlex Air Hose Kits	14	Workforce Truck Tire Inflator Kits.	17
SmartFlex Garden Hose Assemblies.	15	Workforce Rubber Air Hose Assemblies.	17
SmartFlex RV/Marine Hose Assemblies	15	Hose Crimper.	17
Workforce PVC Air Hose Assemblies	16		

18 Air Line Accessories

ColorConnex® Couplers and Plugs	19	Automotive Interchange Coupler and Plug Kits	24
ColorConnex X-Flo™ Couplers.	19	ARO Interchange Couplers and Plugs.	25
Industrial Interchange Couplers	20	ARO Interchange Coupler and Plug Kits	26
Industrial Interchange Plugs.	21	Hose Manifolds	27
Industrial Interchange Coupler and Plug Kits	22	Air Tool Swivels	28
Automotive Interchange Couplers and Plugs	23	Universal Interchange Couplers	28

29 Tire Maintenance

Workforce Tire Gauges.	30-31
Workforce Tire Chucks and Inflators	31

32 Blow Guns

Workforce Telescoping and Extended Blow Guns.	33
Workforce Lever Blow Guns.	33

Greasing Equipment

34

Lock-n-Load™ Grease Guns	35-37	Workforce Metric Grease Fittings	47
Workforce Grease Guns	38	Workforce Drive Type Grease Fittings	47
Workforce® Pro Heavy-Duty Grease Guns	39	Workforce Grease Fitting Assortments – Standard and Metric	48
Workforce Suction Gun	39	Workforce Grease Fitting Repair Tools	49
Workforce Grease Couplers	40-42	Workforce Manual Grease Transfer Pump Accessories	49
Workforce™ Grease Hoses - Standard-Duty Rubber	43	Performance™ Series Greasing Systems and Grease Pumps	50
Workforce Grease Hoses - Thermoplastic	44	Drum Dollies	51
Workforce Grease Accessories	45	Performance Series Control Guns	51
Workforce® Pro Lubrication Accessory Kits	46	Z-Swivel for Grease Control Guns	51
Workforce Standard Grease Fittings	47	Manual Grease Transfer Pumps	52

Oil Pumping Equipment

53

Performance Series Air-Operated Oil Pumps	54-56	Workforce Manual Transfer Pumps - Rotary Action	58
Performance Series Electronically Metered Oil Control Guns	57	Workforce Manual Oil Transfer Pumps - Lever Action	59
Oil Control Guns - Manual	58	Workforce Manual Oil Transfer Pumps - Lift Action	60

Plan-O-Grams and Part Number Index

61

Plan-O-Grams	61-64
Part Number Index	65-66

Hose Reels



Legacy™

LEVELWIND™

Levelwind™ Technology

This unique winding system automatically layers the hose back and forth across the reel. This ensures that the hose is coiled smoothly and easily every time.

Latching Mode Switch

Choose from latching hose every 3 ft. for extended use or switch to free run for immediate automatic rewinding

Levelwind™ Retractable Hose Reels

Levelwind™ Technology - This unique winding system automatically layers the hose back and forth across the reel ensuring that the hose is coiled smoothly, easily...every time. Levelwind reels include hose and lead-in hose.



L8305

FEATURES:

- **Latching Mode Switch** - Choose from latching hose every 3 ft. for extended use or switch to free run for immediate automatic rewinding
- **Seven Position Locking Bracket** - These reels can swivel freely on the mounting bracket up to 135° or can be locked into place using the locking brace. Up to seven different locking angles can be utilized (L8300-W)
- **Adjustable Hose Stopper** - Increase or decrease the length of the hose that remains when the hose is fully retracted
- **Extra Large Swivel** - A 3/4 in. swivel reduces flow restrictions and allows for maximum flow
- **Freestanding Base** - Portable - Use freestanding or mounted on wall or ceiling. Flat base allows reel to rest on ground
- **Built-In Handle** - For carrying ease
- **Durable Construction** - Made from durable UV stabilized polypropylene
- **Hoses Included** - PVC or reinforced rubber twin hose and lead-in hose included
- **Assembled in USA of US and global components**

Levelwind™ Retractable Hose Reels (continued)

Part No.	Application	Hose I.D.	Hose Length	Hose Material	Working Pressure @ 70°F	Temperature Range (F°)	Hose Inlet	Hose Outlet	Weight	Retail Pkg
L8305	Air	3/8 in.	50 ft.	PVC	350 psi	15° to 150°	3/4 in.-11½ Male GHT	1/4 in. MNPT	24 lbs.	●
L8306	Air	3/8 in.	75 ft.	PVC	350 psi	15° to 150°	3/4 in.-11½ Male GHT	1/4 in. MNPT	30 lbs.	●
L8310	Air	3/8 in.	100 ft.	PVC	350 psi	15° to 150°	3/4 in.-11½ Male GHT	1/4 in. MNPT	31 lbs.	●
L8335*	Air/Water	1/2 in.	50 ft.	PVC	300 psi	15° to 150°	3/4 in.-11½ Male GHT	1/2 in. MNPT	27 lbs.	●
L8344	Garden	5/8 in.	60 ft.	PVC	140 psi	40° to 140°	3/4 in.-11½ Male GHT	3/4 in.-11½ Male GHT	31 lbs.	●
L8345	Garden	1/2 in.	75 ft.	PVC	140 psi	40° to 140°	3/4 in.-11½ Male GHT	3/4 in.-11½ Male GHT	29 lbs.	●
L8346	Garden	5/8 in.	50 ft.	PVC	140 psi	40° to 140°	3/4 in.-11½ Male GHT	3/4 in.-11½ Male GHT	25 lbs.	●
L8349**	Cold Water Washdown	5/8 in.	50 ft.	PVC	140 psi	40° to 140°	3/4 in.-11½ Male GHT	3/4 in.-11½ Male GHT	24 lbs.	-
L8350	Potable Water	1/2 in.	75 ft.	PVC	140 psi	40° to 140°	3/4 in.-11½ Male GHT	3/4 in.-11½ Male GHT	28 lbs.	-

*Garden hose adapters included for discharge and lead-in hoses

**Model L8349 is designed for safe water drinking/food service applications



L8344



L8305



L8344 Retail Package



L8305 Retail Package

Lead-in Hoses and Mounting Brackets - Levelwind™ Reels

L8300-W FEATURES:

- Includes a seven position locking brace
- Reel can swivel freely on the mounting bracket up to 135° or can be locked into place using the locking brace
- Mounting options: wall or overhead ceiling



L8300-W

L8300-B FEATURES:

- Includes a seven position locking brace
- Reel can swivel freely on the mounting bracket up to 360° or can be locked into place using the locking brace
- Up to seven different locking angles can be utilized
- Mounting options: high wall or bench



L8300-B

Part No.	Lead-in Hose For Part Number(s)	Application	Hose I.D.	Hose Length	Fittings	Hose Material	Working Pressure @ 70°F	Temperature Range (F°)	Retail Packaging
L8305LI	L8305, L8306, L8310	Compressed Air	3/8 in.	3 ft.	1/4 in. MNPT x 3/4 in.-11½ Female GHT	PVC	300 psi	40° to 140°	–
L8305LI-10	L8305, L8306, L8310	Compressed Air	3/8 in.	10 ft.	1/4 in. MNPT x 3/4 in.-11½ Female GHT	PVC	300 psi	40° to 140°	–
L8335LI	L8335	Air/Water	1/2 in.	3 ft.	1/2 in. MNPT x 3/4 in.-11½ Female GHT	PVC	300 psi	40° to 140°	–
L8335LI-10	L8335, L8344, L8346, L8349	Air/Water	1/2 in.	10 ft.	1/2 in. MNPT x 3/4 in.-11½ Female GHT	PVC	300 psi	40° to 140°	–
L8349LI	L8349	Cold Water	5/8 in.	5 ft.	3/4 in.-11½ Female GHT	PVC	140 psi	40° to 140°	–
L8349LI-10	L8349	Cold Water	5/8 in.	10 ft.	3/4 in.-11½ Female GHT	PVC	140 psi	40° to 140°	–



L8305LI-10

Workforce® Retractable Open Face Hose Reels - Single Axle Arm

These retractable, open face hose reels are ideal for indoor shop and industrial applications.

FEATURES:

- **Multi-Position Guide Arm** - Allows mounting on wall, tank or overhead
- **Durable Heavy-Duty Steel Construction** - Provides strength and stability to the reel and bracket
- **Corrosion-Resistant Powder Coating** - Provides extra measure of protection against the elements
- **Four-Way Direction Rollers** - Allow the hose to be easily pulled from the reel
- **Self-Locking Fasteners** - Stay tight even in mobile installations
- **Narrow Size** - Ideal for easy placement and storage
- **Multi-Position Release Ratchet** - Allows appropriate amount of hose to be extended for each job site
- **Metal Latching Pawl** - Makes an audible clicking sound allowing the latching zone to be locked quickly and easily
- **Fully-Enclosed Spring** - Packed with grease for extended life
- **Lead-in Hose Included** - 5 ft. Rubber or SAE 100R1 or R2 lead-in hose (1/4 in. MNPT x 1/4 in. NPSM female swivel)



L8641

Reel Part No.	Application	Hose I.D.	Hose Length	Hose Material	Working Pressure @ 70°F	Temperature Range (F°)	Reel Inlet	Hose Outlet	Weight	Retail Packaging
L8611	Compressed Air	3/8 in.	50 ft.	Rubber	300 psi	-4° to 140° F	3/8 in. FNPT	1/4 in.*	36 lbs.	●
L8621	Grease	1/4 in.	50 ft.	SAE 100R2	5,000 psi	0° to 190° F	1/4 in. FNPT	1/4 in. MNPT	62 lbs.	-
L8631	Oil	1/2 in.	50 ft.	SAE 100R1	2,000 psi	0° to 190° F	1/2 in. FNPT	1/2 in. MNPT	62 lbs.	-
L8632	Oil	1/2 in.	30 ft.	SAE 100R1	2,000 psi	0° to 190° F	1/2 in. FNPT	1/2 in. MNPT	55 lbs.	-
L8641**	Air/Water	1/2 in.	50 ft.	Rubber	300 psi	-4° to 140° F	1/2 in. FNPT	1/2 in. MNPT	57 lbs.	●

*1/4 in. MNPT x 3/8 in. bushing included

**40°F to 140°F for water application

Workforce® Manual Open Face Air Hose Reels - Fixed

These manual heavy-duty drum reels are compact and ideal for indoor shop and industrial applications.



Part No.	Application	Hose I.D.	Hose Length	Hose Material	Working Pressure @ 70°F	Temperature Range (F°)	Reel Inlet	Hose Outlet	Weight	Retail Packaging
L8650	Compressed Air	3/8 in.	50 ft.	PVC	300 psi	40° to 140°	1/4 in. FNPT	1/4 in. MNPT	14 lbs.	●
L8652	Compressed Air	3/8 in.	100 ft.	300 psi	40° to 140°	1/4 in. FNPT	1/4 in. MNPT	29 lbs.	●	

FEATURES:

- **Heavy-Duty Drum** - Heavy-duty steel reinforced drum. Powder coat paint provides a smooth and durable finish
- **Bend Restrictor** - Prolongs the life of the air hose
- **Brake** - Keeps hose from unwinding unintentionally
- **Inlet Swivel** - Heavy-duty 1/4 in. brass
- **Tapered Side Walls** - Store more hose in less space
- **Swivel Handle** - Pivots in hand for winding ease
- **Mounting Bracket** - Mount reel to wall, workbench or vehicle with ease
- **Dual Support** - Provides extra stability for the big jobs (L8652 only)
- **Lead-in Hose Included** - 3 ft. x 3/8 in.



Workforce® Manual Open Face Air Hose Reels

These manual open face hose reels are ideal for indoor shop and industrial applications.



FEATURES:

- **Swivel Handle** - Pivots in hand for winding ease
- **Mounting Bracket** - Mount reel to wall, workbench or vehicle with ease
- **Swivel** - Heavy-duty 1/4 in. brass
- **Baked Enamel Finish** - Provides a smooth and durable finish
- **Bend Restrictor** - Prolongs the life of the air hose
- **Lead-in Hose Included** - 3 ft. x 3/8 in. with solid brass fittings



L8550

L8550 Retail Packaging

Part No.	Application	Hose I.D.	Hose Length	Hose Material	Working Pressure @ 70°F	Temperature Range (F°)	Reel Inlet	Hose Outlet	Weight	Retail Packaging
L8550	Compressed Air	3/8 in.	50 ft.	PVC	300 psi	40° to 140°	1/4 in. FNPT	1/4 in. MNPT	15 lbs.	●
L8560	Compressed Air	3/8 in.	100 ft.	PVC	300 psi	40° to 140°	1/4 in. FNPT	1/4 in. MNPT	18 lbs.	—

Hoses



SMARTFLEX[®]

SmartFlex[®]

SmartFlex[®] Hybrid Polymer Blend hoses offer premium performance at a mid-level price point. SmartFlex offers quality and value and is a great choice for the smart DIY shoppers.

SmartFlex®

SmartFlex® Hybrid Polymer Blend air hoses offer premium performance at a mid-level price point. They have an abrasion-resistant outer cover for durability. SmartFlex offers quality and value and is a great choice for the smart DIY shoppers.

Air Hose Assemblies

FROM THE MAKERS OF **FLEXZILLA®**

FEATURES:

- Cold weather flexibility
- Kink-resistant under pressure
- Abrasion-resistant outer cover
- Working pressure: 300 psi

Part No.	Color	Hose I.D.	Hose Length	Fittings	Retail Packaging
HSF1450BL2	Blue	1/4 in.	50 ft.	1/4 in. MNPT	●
HSF14100BL2	Blue	1/4 in.	100 ft.	1/4 in. MNPT	●
HSF3825BL2	Blue	3/8 in.	25 ft.	1/4 in. MNPT	●
HSF3850BL2	Blue	3/8 in.	50 ft.	1/4 in. MNPT	●
HSF38100BL2	Blue	3/8 in.	100 ft.	1/4 in. MNPT	●



HSF3850BL2



HSF3850BL2 Retail Packaging

Air Hose Kits - Include Hose, Coupler and Plug

This convenient hose kit features the revolutionary SmartFlex air hose paired with a brass coupler and a steel plug (one each). Plus, since thread sealer is already installed on the coupler and plug, you're ready to go as soon as you reach the job site.

KIT INCLUDES:

- SmartFlex Air Hose
- Brass Coupler - Industrial (Type D)
- Steel Plug - Industrial (Type D)
- Pre-sealed Threads

Part No.	Color	Hose I.D.	Hose Length	Fittings	Retail Packaging
HSF1450BL2-1	Blue	1/4 in.	50 ft.	1/4 in. MNPT	●
HSF14100BL2-1	Blue	1/4 in.	100 ft.	1/4 in. MNPT	●
HSF3850BL2-1	Blue	3/8 in.	50 ft.	1/4 in. MNPT	●
HSF38100BL2-1	Blue	3/8 in.	100 ft.	1/4 in. MNPT	●



HSF3850BL2-1

SmartFlex®

SmartFlex® hoses feature a Hybrid Polymer Blend material and offer premium performance at a mid-level price point. They also have an abrasion-resistant outer cover for durability. The easy grip water hoses offer superior ergonomics with a SwivelGrip™ handle on the female end that makes them easy to attach and detach at the spigot. SmartFlex is an adaptable, swivel-handle hose that's a great choice for smart DIY shoppers. The Hybrid Polymer Blend inner tube material is drinking water safe.

Garden & RV/Marine Hose Assemblies FROM THE MAKERS OF FLEXZILLA®

FEATURES:

- Female SwivelGrip™ connection makes connecting to the spigot easy
- Cold-weather flexibility
- Kink-resistant under pressure
- Abrasion-resistant outer cover
- Superior ergonomics
- Drinking water safe



Part No.	Color	Hose I.D.	Hose Length	Fittings	Retail Packaging
HSFG550GR	Green	5/8 in.	50 ft.	3/4 in. - 1 1/2" GHT	●
HSFG575GR	Green	5/8 in.	75 ft.	3/4 in. - 1 1/2" GHT	●
HSFG5100GR	Green	5/8 in.	100 ft.	3/4 in. - 1 1/2" GHT	●
HSFRV425	White	1/2 in.	25 ft.	3/4 in. - 1 1/2" GHT	●
HSFRV450	White	1/2 in.	50 ft.	3/4 in. - 1 1/2" GHT	●
HSFRV525	White	5/8 in.	25 ft.	3/4 in. - 1 1/2" GHT	●
HSFRV550	White	5/8 in.	50 ft.	3/4 in. - 1 1/2" GHT	●



Workforce®

PVC Air Hose Assemblies

Workforce® PVC air hose is made from virgin resin PVC, giving it excellent flexibility and low temperature resistance. The outer cover also uses virgin resin PVC that is UV, oil and abrasion resistant. The inner tube is reinforced with extra strong polyester braiding which is 20% lighter per foot than comparable rubber hoses. This air hose resists cracking and fading. If coupling, use crimped-on fittings only. Reusable fittings not recommended.

FEATURES:

- Outer cover and inner tube are made from the highest quality PVC materials.
- Temp. Range: 15° to 150°F
- Twin Spiral Braiding - Extra strong polyester textile cord adds reinforcement to inner tube
- Cover is oil and abrasion-resistant and non-marring
- Includes bend restrictor that reduces wear and tear, prolonging the life of the hose
- Corrosion-resistant solid brass NPT fittings

Part No.	Color	Hose I.D.	Hose Length	Working Pressure @ 70°F	Fittings	Retail Pkg
HWF1425RD2	Red	1/4 in.	25 ft.	300 psi	1/4 in. MNPT	–
HWF3825FO2	Orange	3/8 in.	25 ft.	350 psi	1/4 in. MNPT	●
HWF3825RD2	Red	3/8 in.	25 ft.	350 psi	1/4 in. MNPT	●
HWF3825BL2	Blue	3/8 in.	25 ft.	350 psi	1/4 in. MNPT	●
HWF3850RD2	Red	3/8 in.	50 ft.	350 psi	1/4 in. MNPT	●
HWF3850BL2	Blue	3/8 in.	50 ft.	350 psi	1/4 in. MNPT	●
HWF3850FO2	Orange	3/8 in.	50 ft.	350 psi	1/4 in. MNPT	●
HWF3850YW2	Yellow	3/8 in.	50 ft.	350 psi	1/4 in. MNPT	●
HL23850FO2-A02	Orange	3/8 in.	50 ft.	200 psi	1/4 in. MNPT	●
HWF1250BL3	Blue	1/2 in.	50 ft.	300 psi	3/8 in. MNPT	–
HWF1250BL4	Blue	1/2 in.	50 ft.	300 psi	1/2 in. MNPT	–



PVC Whip Hose Assemblies

Short hoses for making connections to tools and carry tanks.

Part No.	Color	Hose Length	Hose I.D.	Fittings	Retail Packaging
HWF3805RD2B	Red	5 ft.	3/8 in.	1/4 in. MNPT Ball Swivel	●
HWF1404RD2	Red	4 ft.	1/4 in.	1/4 in. MNPT	●



Workforce® (continued)

Truck Tire Inflator Kits - Include Hose, Glad-hand and Chuck

Workforce® truck tire inflator kits use truck's on-board air supply to inflate tires in remote situations.

Part No.	Color	Hose I.D.	Hose Length	Fittings	Retail Packaging
HGH1	Orange	3/8 in.	50 ft.	1/4 in. MNPT	-
HGH2	Blue	3/8 in.	50 ft.	1/4 in. MNPT	-

HGH1 KIT INCLUDES:

- Glad-hand attachment, 30° dual angle air chuck

HGH2 KIT INCLUDES:

- Glad-hand attachment, 30° angle and straight-on air chuck



Rubber Air Hose Assemblies

Workforce rubber hose assemblies are designed for a wide range of industrial, construction and agricultural applications. Featuring reinforced synthetic rubber tube and cover with a synthetic yarn weave for extra strength and flexibility.

FEATURES:

- Construction:
 - Tube - RMA Class C
 - Cover - Synthetic rubber
- Temp. range: -20° to 140°F
- Working pressure: 300 psi

Part No.	Hose I.D.	Hose Length	Fittings	Retail Packaging
HRE1225RD3	1/2 in.	25 ft.	3/8 in. MNPT	●
HRE1250RD3	1/2 in.	50 ft.	3/8 in. MNPT	●
HRE1425RD2	1/4 in.	25 ft.	1/4 in. MNPT	●
HRE1450RD2	1/4 in.	50 ft.	1/4 in. MNPT	●
HRE3825RD2	3/8 in.	25 ft.	1/4 in. MNPT	●
HRE3835RD2	3/8 in.	35 ft.	1/4 in. MNPT	●
HRE3850RD2	3/8 in.	50 ft.	1/4 in. MNPT	●



Hose Crimper

Part No.	Die Bore Sizes	Retail Packaging
A5	5/8 in. 37/64 in. (for 3/8 in. Flexzilla) 17/32 in. 7/16 in. (For 1/4 in. Flexzilla) 11/16 in. (For 1/2 in. Flexzilla)	-

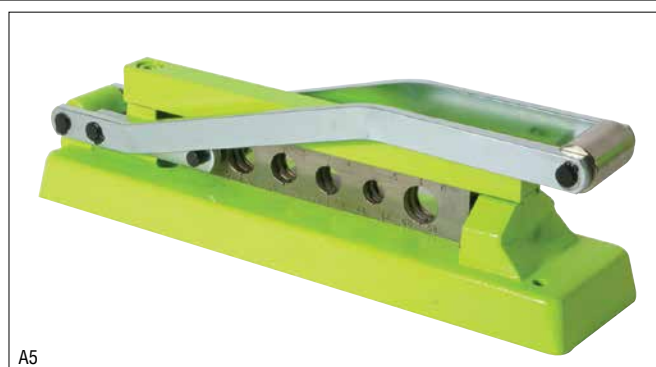

Air Line Accessories

The ColorConnex® System

ColorConnex is a patented system that allows color-to-color matching of couplers and plugs among the standard pneumatic interchanges.



ColorConnex®

ColorConnex® is a patented system that allows color-to-color matching of couplers and plugs among the standard pneumatic interchanges.

- Industrial (Type D): Red
- Automotive (Type C): Blue
- ARO (Type B): Green

By using **ColorConnex** to dedicate line use, you can ensure you never use a lubricated line for a dry line application, preventing cross contamination.

- **Match coupler and plug types**
- **Dedicate hose applications**



ColorConnex® X-Flo™

ColorConnex® X-Flo™ couplers provide 25% more air to your tool than standard couplers. By reducing internal resistance, more air is provided to your tool, resulting in better tool performance.

ColorConnex® X-Flo™ couplers are compatible with the associated ColorConnex plug types.

- **25% More Flow**
- **Push-To-Connect**



Industrial Interchange

Couplers

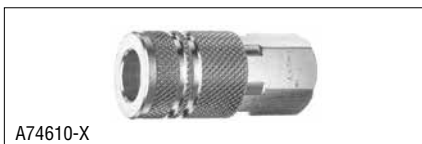
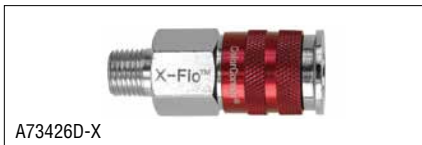
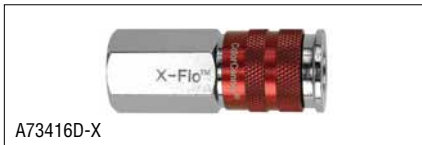

Part No.	Color	Type	Interchange	Connection Size	Body Size	Max. Pressure	Material	Retail Packaging
ColorConnex® Couplers								
A73410D-X	Red	D	Industrial	1/4 in. FNPT	1/4 in.	300 psi	Steel/Aluminum*	–
A73410D	Red	D	Industrial	1/4 in. FNPT	1/4 in.	300 psi	Steel/Aluminum*	●
A73420D-X	Red	D	Industrial	1/4 in. MNPT	1/4 in.	300 psi	Steel/Aluminum*	–
A73420D	Red	D	Industrial	1/4 in. MNPT	1/4 in.	300 psi	Steel/Aluminum*	●
ColorConnex® X-Flo™ Couplers								
A73416D	Red	D	Industrial	1/4 in. FNPT	1/4 in.	300 psi	Steel/Aluminum*	●
A73416D-X	Red	D	Industrial	1/4 in. FNPT	1/4 in.	300 psi	Steel/Aluminum*	–
A73426D	Red	D	Industrial	1/4 in. MNPT	1/4 in.	300 psi	Steel/Aluminum*	●
A73426D-X	Red	D	Industrial	1/4 in. MNPT	1/4 in.	300 psi	Steel/Aluminum*	–
Sleeve Type Couplers								
A73410-X	NA	D	Industrial	1/4 in. FNPT	1/4 in.	300 psi	Steel	–
A73415-X	NA	D	Industrial	1/4 in. FNPT	1/4 in.	300 psi	Brass	–
A73420-X	NA	D	Industrial	1/4 in. MNPT	1/4 in.	300 psi	Steel	–
A73425-X	NA	D	Industrial	1/4 in. MNPT	1/4 in.	300 psi	Brass	–
A73610-X	NA	D	Industrial	3/8 in. FNPT	1/4 in.	300 psi	Steel	–
A73620-X	NA	D	Industrial	3/8 in. MNPT	1/4 in.	300 psi	Steel	–
A74410-X	NA	E	Industrial	1/4 in. FNPT	3/8 in.	300 psi	Steel	–
A75810-X	NA	F	Industrial	1/2 in. FNPT	1/2 in.	300 psi	Steel	–
Hose Barb Couplers								
A73420H-X	NA	D	Industrial	1/4 in. Barb	1/4 in.	300 psi	Steel	–
A73620H-X	NA	D	Industrial	3/8 in. Barb	1/4 in.	300 psi	Steel	–
Part numbers with a -X suffix are individually bagged product and packaged in bulk								
*6061-T6 Aircraft Aluminum								

Industrial Interchange (continued)

Plugs

Part No.	Color	Type	Interchange	Connection Size	Body Size	Max. Pressure	Material	Retail Packaging
ColorConnex® Plugs								
A73430D-X	Red	D	Industrial	1/4 in. FNPT	1/4 in.	300 psi	Aluminum*	—
A73430D-2PK	Red	D	Industrial	1/4 in. FNPT	1/4 in.	300 psi	Aluminum*	●
A73440D-X	Red	D	Industrial	1/4 in. MNPT	1/4 in.	300 psi	Aluminum*	—
A73440D-2PK	Red	D	Industrial	1/4 in. MNPT	1/4 in.	300 psi	Aluminum*	●
NPT Plugs								
A73430-X	NA	D	Industrial	1/4 in. FNPT	1/4 in.	300 psi	Steel	—
A73435-X	NA	D	Industrial	1/4 in. FNPT	1/4 in.	300 psi	Brass	—
A73440-X	NA	D	Industrial	1/4 in. MNPT	1/4 in.	300 psi	Steel	—
A73445-X	NA	D	Industrial	1/4 in. MNPT	1/4 in.	300 psi	Brass	—
A73640-X	NA	D	Industrial	3/8 in. MNPT	1/4 in.	300 psi	Steel	—
A75830-X	NA	F	Industrial	1/2 in. FNPT	1/2 in.	300 psi	Steel	—
Hose Barb Plugs								
A73440H-X	NA	D	Industrial	1/4 in. Barb	1/4 in.	300 psi	Steel	—
A73640H-X	NA	D	Industrial	3/8 in. Barb	1/4 in.	300 psi	Steel	—
Part numbers with a -X suffix are individually bagged product and packaged in bulk								
*6061-T6 Aircraft Aluminum								

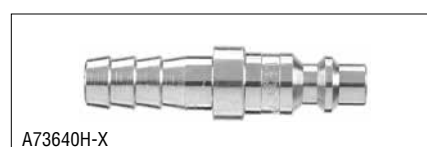

Industrial Interchange (continued)

Coupler and Plug Kits

Part No.	Color	Type	Interchange	Connection Size	Body Size	Max. Pressure	Material	Contents	Bulk Quantity	Retail Pkg
ColorConnex® 8-Pc. Plug Kit										
A73440D-8PK	Red	D	Industrial	1/4 in. NPT	1/4 in.	300 psi	Steel/Aluminum*	(8) MNPT Plugs	NA	●
ColorConnex® 3-Pc. Coupler and Plug Kit										
A73452D	Red	D	Industrial	1/4 in. NPT	1/4 in.	300 psi	Steel/Aluminum*	(1) FNPT Coupler, (1) FNPT Plug and (1) MNPT Plug	NA	●
ColorConnex® 5-Pc. Coupler and Plug Kit										
A73456D	Red	D	Industrial	1/4 in. NPT	1/4 in.	300 psi	Steel/Aluminum*	(1) FNPT Coupler, (1) FNPT Plug and (3) MNPT Plugs	NA	●
ColorConnex® 7-Pc. Coupler and Plug Kit										
A73457D	Red	D	Industrial	1/4 in. NPT	1/4 in.	300 psi	Steel/Aluminum*	(1) FNPT Coupler, (1) MNPT Coupler, (2) FNPT Plugs and (3) MNPT Plugs	NA	●
ColorConnex® 14-Pc. Coupler and Plug Kit										
A73458D	Red	D	Industrial	1/4 in. NPT	1/4 in.	300 psi	Steel/Aluminum*	(2) FNPT Couplers, (2) MNPT Couplers, (4) FNPT Plugs and (6) MNPT Plugs	NA	●

Part numbers with a -X suffix are individually bagged product and packaged in bulk

*6061-T6 Aircraft Aluminum



A73440D-8PK



A73452D



A73456D



A73457D



A73458D



A73458D Retail Packaging

Automotive Interchange

Couplers

Part No.	Color	Type	Interchange	Connection Size	Body Size	Max. Pressure	Material	Retail Packaging
ColorConnex® Couplers								
A72410C	Blue	C	Auto	1/4 in. FNPT	1/4 in.	300 psi	Steel/Aluminum*	●
A72410C-X	Blue	C	Auto	1/4 in. FNPT	1/4 in.	300 psi	Steel/Aluminum*	–
A72420C	Blue	C	Auto	1/4 in. MNPT	1/4 in.	300 psi	Steel/Aluminum*	●
A72420C-X	Blue	C	Auto	1/4 in. MNPT	1/4 in.	300 psi	Steel/Aluminum*	–
ColorConnex® X-Flo™ Couplers								
A72416C	Blue	C	Auto	1/4 in. FNPT	1/4 in.	300 psi	Steel/Aluminum*	●
A72416C-X	Blue	C	Auto	1/4 in. FNPT	1/4 in.	300 psi	Steel/Aluminum*	–
A72426C	Blue	C	Auto	1/4 in. MNPT	1/4 in.	300 psi	Steel/Aluminum*	●
Part numbers with a -X suffix are individually bagged product and packaged in bulk								
*6061-T6 Aircraft Aluminum								

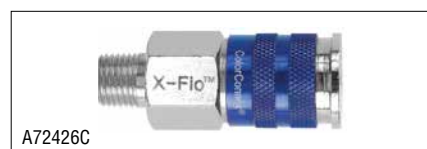

Plugs

Part No.	Color	Type	Interchange	Connection Size	Body Size	Max. Pressure	Material	Retail Packaging
ColorConnex® Plugs								
A72430C-X	Blue	C	Auto	1/4 in. FNPT	1/4 in.	300 psi	Aluminum*	–
A72430C-2PK	Blue	C	Auto	1/4 in. FNPT	1/4 in.	300 psi	Aluminum*	●
A72440C-X	Blue	C	Auto	1/4 in. MNPT	1/4 in.	300 psi	Aluminum*	–
A72440C-2PK	Blue	C	Auto	1/4 in. MNPT	1/4 in.	300 psi	Aluminum*	●
A72630C-X	Blue	C	Auto	3/8 in. FNPT	1/4 in.	300 psi	Aluminum*	–
A72640C-X	Blue	C	Auto	3/8 in. MNPT	1/4 in.	300 psi	Aluminum*	–
NPT Plugs								
A72430	NA	C	Auto	1/4 in. FNPT	1/4 in.	300 psi	Steel	●
A72430-X	NA	C	Auto	1/4 in. FNPT	1/4 in.	300 psi	Steel	–
A72440	NA	C	Auto	1/4 in. MNPT	1/4 in.	300 psi	Steel	●
A72440-X	NA	C	Auto	1/4 in. MNPT	1/4 in.	300 psi	Steel	–
A72640-X	NA	C	Auto	3/8 in. MNPT	1/4 in.	300 psi	Steel	–
Part numbers with a -X suffix are individually bagged product and packaged in bulk								
*6061-T6 Aircraft Aluminum								



Automotive Interchange (continued)

Coupler and Plug Kits

Part No.	Color	Type	Interchange	Connection Size	Body Size	Max. Pressure	Material	Contents	Bulk Quantity	Retail Pkg
ColorConnex® 8-Pc. Plug Kit										
A72440C-8PK	Blue	C	Auto	1/4 in. NPT	1/4 in.	300 psi	Steel/Aluminum*	(8) MNPT Plugs	NA	●
ColorConnex® 3-Pc. Coupler and Plug Kit										
A72452C	Blue	C	Auto	1/4 in. NPT	1/4 in.	300 psi	Steel/Aluminum*	(1) FNPT Coupler, (1) FNPT Plug and (1) MNPT Plug	NA	●
ColorConnex® 5-Pc. Coupler and Plug Kit										
A72456C	Blue	C	Auto	1/4 in. NPT	1/4 in.	300 psi	Steel/Aluminum*	(1) FNPT Coupler, (1) FNPT Plug and (3) MNPT Plug	NA	●
ColorConnex® 7-Pc. Coupler and Plug Kit										
A72457C	Blue	C	Auto	1/4 in. NPT	1/4 in.	300 psi	Steel/Aluminum*	(1) FNPT Coupler, (1) MNPT Coupler, (2) FNPT Plugs and (3) MNPT Plugs	NA	●
ColorConnex® 14-Pc. Coupler and Plug Kit										
A72458C	Blue	C	Auto	1/4 in. NPT	1/4 in.	300 psi	Steel/Aluminum*	(2) FNPT Couplers, (2) MNPT Couplers, (4) FNPT Plugs and (6) MNPT Plugs	NA	●
Part numbers with a -X suffix are individually bagged product and packaged in bulk										
*6061-T6 Aircraft Aluminum										



A72440C-8PK



A72452C



A72456C



A72457C



A72458C



A72458C Retail Packaging

ARO Interchange

Couplers

Part No.	Color	Type	Interchange	Connection Size	Body Size	Max. Pressure	Material	Retail Packaging
ColorConnex® Couplers								
A71410B	Green	B	ARO	1/4 in. FNPT	1/4 in.	300 psi	Steel/Aluminum*	●
A71410B-X	Green	B	ARO	1/4 in. FNPT	1/4 in.	300 psi	Steel/Aluminum*	—
A71420B	Green	B	ARO	1/4 in. MNPT	1/4 in.	300 psi	Steel/Aluminum*	●
A71420B-X	Green	B	ARO	1/4 in. MNPT	1/4 in.	300 psi	Steel/Aluminum*	—
ColorConnex® X-Flo™								
A71416B	Green	B	ARO	1/4 in. FNPT	1/4 in.	300 psi	Steel/Aluminum*	●
A71416B-X	Green	B	ARO	1/4 in. FNPT	1/4 in.	300 psi	Steel/Aluminum*	—
A71426B	Green	B	ARO	1/4 in. MNPT	1/4 in.	300 psi	Steel/Aluminum*	●
ARO Interchange Couplers								
A71410-X	NA	B	ARO	1/4 in. FNPT	1/4 in.	300 psi	Steel	—

Part numbers with a -X suffix are individually bagged product and packaged in bulk
 *6061-T6 Aircraft Aluminum

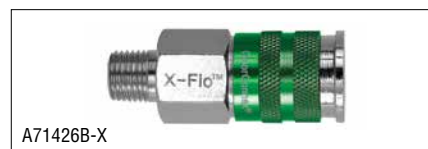
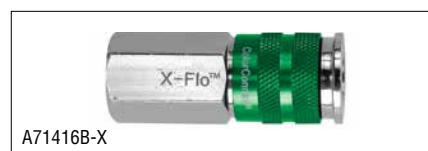

Plugs

Part No.	Color	Type	Interchange	Connection Size	Body Size	Max. Pressure	Material	Retail Packaging
ColorConnex® Plugs								
A71430B-X	Green	B	ARO	1/4 in. FNPT	1/4 in.	300 psi	Aluminum*	—
A71440B-X	Green	B	ARO	1/4 in. MNPT	1/4 in.	300 psi	Aluminum*	—
A71430B-2PK	Green	B	ARO	1/4 in. FNPT	1/4 in.	300 psi	Aluminum*	●
A71440B-2PK	Green	B	ARO	1/4 in. MNPT	1/4 in.	300 psi	Aluminum*	●
ARO Interchange Plugs								
A71440-X	NA	B	ARO	1/4 in. MNPT	1/4 in.	300 psi	Steel	—

Part numbers with a -X suffix are individually bagged product and packaged in bulk
 *6061-T6 Aircraft Aluminum



ARO Interchange (continued)

Coupler and Plug Kits

Part No.	Color	Type	Interchange	Connection Size	Body Size	Max. Pressure	Material	Contents	Bulk Quantity	Retail Pkg
ColorConnex® 8-Pc. Plug Kit										
A71440B-8PK	Green	B	ARO	1/4 in. NPT	1/4 in.	300 psi	Steel/Aluminum*	(8) MNPT Plugs	NA	●
ColorConnex® 3-Pc. Coupler and Plug Kit										
A71452B	Green	B	ARO	1/4 in. NPT	1/4 in.	300 psi	Steel/Aluminum*	(1) FNPT Coupler, (1) MNPT Plug and (1) FNPT Plug	NA	●
ColorConnex® 5-Pc. Coupler and Plug Kit										
A71456B	Green	B	ARO	1/4 in. NPT	1/4 in.	300 psi	Steel/Aluminum*	(1) FNPT Coupler, (2) MNPT Plugs and (2) FNPT Plugs	NA	●
ColorConnex® 7-Pc. Coupler and Plug Kit										
A71457B	Green	B	ARO	1/4 in. NPT	1/4 in.	300 psi	Steel/Aluminum*	(1) FNPT Coupler, (1) MNPT Coupler, (2) FNPT Plugs and (3) MNPT Plugs	NA	●
ColorConnex® 14-Pc. Coupler and Plug Kit										
A71458B	Green	B	ARO	1/4 in. NPT	1/4 in.	300 psi	Steel/Aluminum*	(2) FNPT Couplers, (2) MNPT Couplers, (4) FNPT Plugs and (6) MNPT Plugs	NA	●

Part numbers with a -X suffix are individually bagged product and packaged in bulk

*6061-T6 Aircraft Aluminum



A71440B-8PK



A71452B



A71456B



A71457B



A71458B



A71458B Retail Packaging

Hose Manifolds

Part No.	Color	Type	Interchange	Inlet	Outlet	Includes Manifold Plus	Material	Retail Packaging
3-Way Flat Hex Manifolds								
A84444-D	Red	D	Industrial	1/4 in. Industrial Plug	1/4 in. Industrial Couplers (3)	(3) Red CCX Couplers, (1) Red CCX Plug	Steel/Aluminum*, Brass	-
A84444-X	NA	NA	NA	1/4 in. FNPT	1/4 in. FNPT	NA	Brass	-
3-Way Manifolds								
A94444-X	NA	NA	NA	1/4 in. FNPT	1/4 in. FNPT	NA	Aluminum*	-
A94444DC-X	Red	D	Industrial	1/4 in. Industrial Plug	1/4 in. Industrial Couplers (3)	(3) Red CCX Couplers, (1) Red CCX Plug	Steel/Aluminum*	-

Part numbers with a -X suffix are individually bagged product and packaged in bulk

*6061-T6 Aircraft Aluminum

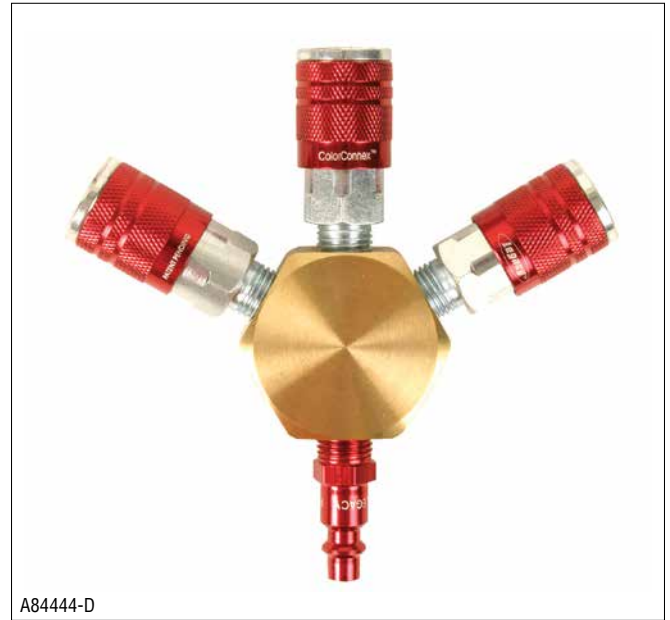

Air Tool Swivels



A9700-X



A1445MFBS-X

Part No.	Color	Type	Interchange	Connection 1	Connection 2	Material	Retail Packaging
360° Block Style							
A9700-X	NA	NA	NA	1/4 in. FNPT	1/4 in. MNPT	Aluminum/Steel	-
A9701-X	NA	NA	NA	3/8 in. MNPT	3/8 in. FNPT	Aluminum/Steel	-
A9702-X	NA	NA	NA	1/2 in. FNPT	1/2 in. MNPT	Aluminum/Steel	-
Ball Swivel							
A1445MFBS-X	NA	NA	NA	1/4 in. MNPT	1/4 in. FNPT	Nickel Plated Steel	-
A1640ABS-X	NA	NA	NA	1/4 in. MNPT	3/8 in. Barb	Aluminum	-

Part numbers with a -X suffix are individually bagged product and packaged in bulk

Universal Interchange Couplers



A77410-X



A77415

Part No.	Color	Interchange	Connection Size	Body Size	Max. Pressure	Material	Retail Packaging
Universal Couplers							
A77410-X	NA	Universal	1/4 in. FNPT	1/4 in.	250 psi	Steel	-
A77415	NA	Universal	1/4 in. FNPT	1/4 in.	250 psi	Brass	●
A77420-X	NA	Universal	1/4 in. MNPT	1/4 in.	250 psi	Steel	-

Tire Maintenance



Inflate Tires With Ease

Workforce® tire inflators deliver accurate pressure to car, truck, bike and off-road tires.

Workforce® Tire Gauges

Proper tire pressure is critical to maximizing the performance and life of tires. It also increases gas mileage, improves vehicle handling and helps prevent blowouts.



TH0300 - Economy Pencil Tire Pressure Gauge

FEATURES:

- Reads from 5 to 50 psi



TH0301 - Automotive Pencil Tire Pressure Gauge

FEATURES:

- Reads from 10 to 50 psi
- Calibrated in psi and kPa
- This gauge has a 4-sided bar

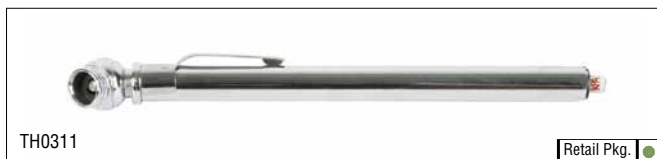

TH0311 - Bicycle Tire Pressure Gauge

FEATURES:

- Reads from 10 to 120 psi



TH0330 - Tread Depth Tire Gauge

FEATURES:

- Calibrated in 1/32 in. units
- Replace tire if center groove is less than 2/32 in. deep



TH0306 - Reverse Dual Foot Tire Pressure Gauge, Pencil Type

FEATURES:

- Reads from 10 to 120 psi
- Reverse dual foot head simplifies reading pressure on inner dual wheels
- This gauge has a 4-sided bar



TH0307 - Heavy-Duty Truck and Bus Dual Head Tire Pressure Gauge

FEATURES:

- Reads from 10 to 150 psi
- Reverse dual foot head simplifies reading pressure on inner dual wheels



TH0317 - Heavy-Duty Truck and Bus Straight-On Dual Head Tire Pressure Gauge

FEATURES:

- Reads from 10 to 150 psi
- Reverse dual foot head simplifies reading pressure on inner dual wheels

Workforce® Tire Gauges (continued)



TH0303

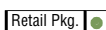

TH0303 - Mini Dial Tire Gauge

FEATURES:

- Reads from 0 to 60 psi



TH0308

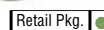

TH0308 - 2 in. Dial Tire Gauge with Angled Chuck and Bleeder

FEATURES:

- Reads from 0 to 60 psi
- Dual scale calibrated in psi and kPa
- Needle holds reading until released by pressing button
- For use with cars, motorcycles and inflatables

Workforce® Tire Chucks and Inflators

Tire Inflators



AL2010

AL2010 FEATURES:

- Straight-on chuck with 12 in. hose
- Heavy-duty gauge
- Indicator bar calibrated in 2 psi increments from 10 to 90 psi



AL2050

AL2050 FEATURES:

- Air inflator provides user with easy controlled inflation
- For use with direct lines
- Chrome plated steel dual chuck, 6 in.
- Cast zinc alloy body with heavy-duty brass valves
- Easy to read recessed glass sight pressure gauge
- Indicator bar calibrated in 2 psi increments from 10 to 120 psi
- Lightweight, yet stands the pounding of hard surfaces
- Heavy-duty rubber hose, 12 in.

Part No.	Type	Inlet FNPT	Body Material	Retail Packaging
AL2010	Chuck Inflator	1/4 in.	Die-cast Zinc	●
AL2050	Dual Foot Chuck Inflator	1/4 in.	Die-cast Zinc	●

Tire Chucks

Part No.	Type	Inlet FNPT	Body Material	Retail Packaging
AL3000	Ball Chuck	1/4 in.	Brass/Zinc	●
AL3010	Ball Chuck with Clip	1/4 in.	Brass/Zinc	●
AL3025	Dual Foot Chuck	1/4 in.	Brass/Zinc	●



AL3000



AL3025

Blow Guns

Blow Guns

Ideal for applications in the garage, shop and worksite.

Workforce® Telescoping and Extended Blow Guns

Blow Guns featuring our telescoping extension improves reach without refitting the gun. Maximum inlet air pressure: 110 psi.

Part No.	Inlet FNPT	Overall Length	Nozzle	Max. dBA	Air Consumption (SCFM)	Body Material	Retail Pkg
AG2-10*	1/4 in.	12.5 in. to 17.5 in.	Rubber	87	13	ABS	●
AG4-10*	1/4 in.	12.5 in.	Rubber	87	13	ABS	●
AGKIT**	1/4 in.	12.5 in. to 17.5 in.	Rubber	87	13	ABS	●

*U.S. Pat. No. D562,661 S and 6,698,672 B1

**U.S. Pat. No. D562,661 S, 6,698,672 B1 and 6,561,233 B2

AGKIT – 6-Piece Blow Gun Kit

This modular kit features an ergonomic blow gun handle that allows 3 specialized extensions to be connected with ease.

- **Inflators**

Ideal for inflating air mattresses and sports equipment.

- **Car/Truck Tire Inflator**

This tire inflator nozzle, with dual air chuck, has a unique design that allows for the purging of moisture from air lines prior to inflating tires. Doubles as a blow gun. Simply pull the trigger on handle for a steady stream of air.

- **360° Adjustable Blow Gun Nozzle**

Adjustable length blow gun nozzle rotates a full 360° and locks at any length between 6.5 and 11 in., making it ideal for tight or hard-to-reach spaces. Includes a threaded removable rubber tip.



AG2-10



AG4-10



AGKIT

Workforce® Lever Blow Guns

Lever-trigger blow guns for most frequent-use applications. Can be disassembled for cleaning or repair using common o-rings.



Part No.	Inlet FNPT	Outlet NPSM Female	Overall Length	Nozzle (see below for nozzle reference chart)	Max. dBA	Air Consumption (SCFM)	Color	Retail Packaging
Plated Zinc (Maximum inlet air pressure: 150 psi)								
AG7	1/4 in.	1/8 in.	5 in.	Standard Rubber	87	11	Chrome	●
AG9-X	1/4 in.	1/8 in.	4.25 in.	Standard Self-Relieving, Safety	87	11	Chrome	–
AG206	1/4 in.	*	4.5 in.	Self-Relieving, Tamper Resistant, Safety	87	8	Chrome	●
AG218	1/4 in.	1/8 in.	5.25	High Flow, Safety	87	11	Chrome	●
Electroplated Die-cast Aluminum (Maximum inlet air pressure: 150 psi)								
AG7B	1/4 in.	1/8 in.	5 in.	Standard Rubber	87	11	Green	●
AG7C	1/4 in.	1/8 in.	5 in.	Standard Rubber	87	11	Blue	●
AG7D	1/4 in.	1/8 in.	5 in.	Standard Rubber	87	11	Red	●

* AG206 tip is designed to be non-removable, there is no tip interchange.

Greasing Equipment



Auto Bleeder Valve

Automatically bleeds air when reconnecting barrel to head, reducing air locks and priming problems. Helps to ensure fast priming every time.

Lock-n-Load™ Technology

The Lock-n-Load™ threadless quick connect barrel lets you reload grease in half the time needed with other grease guns. Just slide the Lock-n-Load switch to disengage or reconnect the barrel. Never worry about crossing threads on your barrel again.

Lock-n-Load™ Grease Guns

LOCK-N-LOAD™

THREADLESS BARREL GREASE GUNS

Lock-n-Load™ technology is Legacy's first-in-the-industry system for fast grease reloading. The Lock-n-Load threadless quick connect barrel lets you reload grease in half the time compared to other grease guns. Just slide the Lock-n-Load switch to disengage or reconnect the barrel. Never worry about crossing threads on your barrel again, and get fast priming every time.

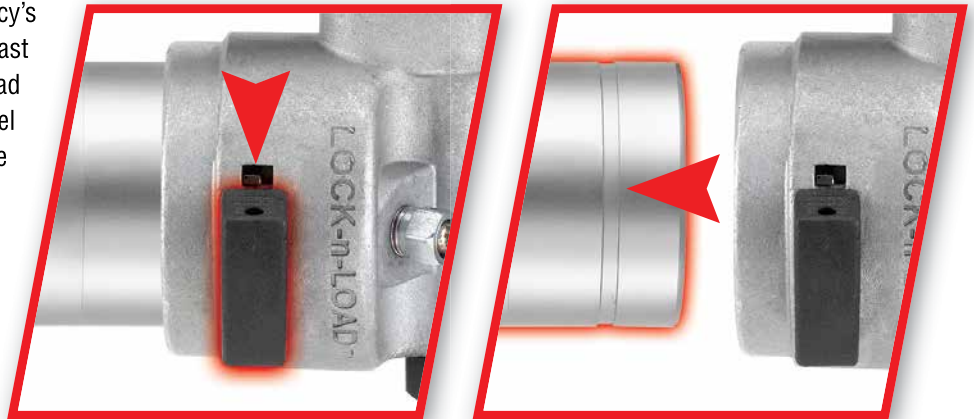

RELOAD 2X FASTER

COMPARED TO THREADED BARREL GREASE GUNS

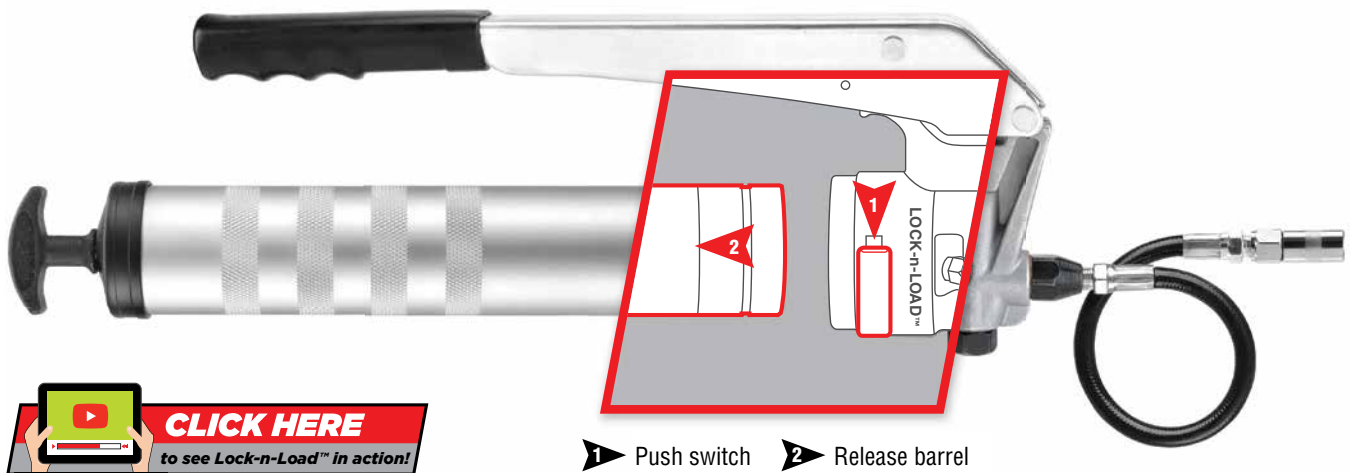

[CLICK HERE](#)
to see Lock-n-Load™ in action!

Lock-n-Load™ Grease Guns (continued)

COMMON FEATURES:

- Lock-n-Load™ threadless quick connect barrel allows you to reload grease in half the time compared to other grease guns
- Automatic Bleeder - Bleeds air when reconnecting barrel to head. Reduces air locks and priming problems
- Heavy-duty Die-cast Head Construction - For maximum durability and longer service life
- 3-Way Loading - Cartridge, bulk, filler nipple
- Lightweight Aluminum Barrel with Firm Grip Knurling - For better grip and durability
- Ergonomic T-grip follower handle
- Holds 14 oz. grease cartridge



L1045L - Lever Action Grease Gun

VARIABLE STROKE

- Allows grease delivery where short strokes are needed

FEATURES:

- Delivers up to 10,000 psi
- Handle fully extended to 45° permits use in tight spaces
- Reinforced handle to withstand demanding environments and rough handling
- Spring loaded handle to facilitate one handed operation
- Handle Lock - Prevents discharge of grease during storage or when working in tight spaces. During use, lock can be stored in handle
- Includes: 4-Jaw coupler for better grip and longer service life, 12 in. flexible grease hose for hard-to-reach grease fittings and 6 in. straight extension
- Strokes per ounce = 26



L1075L - Pistol Grip Grease Gun

VARIABLE STROKE

- Allows grease delivery where short strokes are needed

FEATURES:

- Delivers up to 5,000 psi
- Includes: 4-Jaw coupler for better grip and longer service life, 12 in. flexible grease hose for hard-to-reach grease fittings and 6 in. straight extension
- Strokes per ounce = 32

Lock-n-Load™ Grease Guns (continued)



L1455L - Air Powered Grease Gun

SINGLE SHOT

- 40:1 ratio single shot air motor

FEATURES:

- Post Piston Bleeder - Allows you to initially prime the gun and to regain prime easily
- Bleeder valve for purging unwanted air
- Durable follower rod and spring for consistent priming
- Non-slip knurled aluminum barrel for better grip
- Includes: 4-Jaw coupler for better grip and longer service life, 12 in. flexible grease hose for hard-to-reach grease fittings and 6 in. straight extension
- Includes: Industrial interchange MNPT plug
- Strokes per ounce = 35

L1466L - Air Powered Grease Gun

CONTINUOUS FLOW

- 40:1 ratio continuous flow air motor

FEATURES:

- Post Piston Bleeder - Allows you to initially prime the gun and to regain prime easily
- Bleeder valve for purging unwanted air
- Durable follower rod and spring for consistent priming
- Non-slip knurled aluminum barrel for better grip
- Includes: 4-Jaw coupler for better grip and longer service life, 36 in. flexible grease hose for hard-to-reach grease fittings and 6 in. straight extension
- Includes: Industrial interchange MNPT plug
- Strokes per ounce = 35



L1380L - 12V Cordless Grease Gun Kit

12V CORDLESS

- Delivers up to 6,000 psi

FEATURES:

- Pressure relief valve
- Safety release prevents accidental discharge of grease
- Battery life indicator allows user to easily monitor charge level
- Whip holster and coupler cap permits user to secure grease whip while changing cartridges
- Includes: (2) 12V Ni-Cd rechargeable batteries, 1 hour quick-charger, non-slip aluminum barrel, 4-Jaw coupler, 30 in. flexible grease hose, shoulder strap, and carrying case - durable case for long-lasting protection and storage
- Strokes per minute = 29 ounces



Part No.	Description
L1380-B	Replacement battery
L1380-C	Replacement battery charger

Workforce® Grease Guns

The highest standards for engineering and craftsmanship are built into every Workforce® grease gun making them the choice for those who work under rugged conditions!

COMMON FEATURES:

- Heavy-duty Die-cast Head Construction - For maximum durability and longer active service life
- Durable Follower Rod and Spring - For consistent priming
- Holds 14 oz. grease cartridge (except L1305)

L1305 - Mini Grease Gun

FEATURES:

- 3 oz. cartridge loading
- Chrome finish
- Includes: 12 in. flexible grease hose and 4 in. straight extension

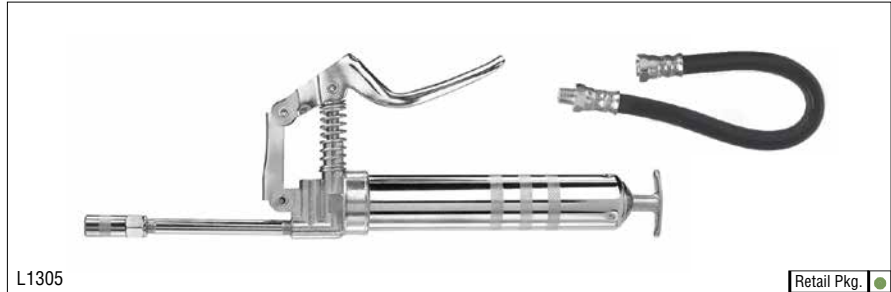

L1305

Retail Pkg.

L1310 - Lever Grease Gun

FEATURES:

- Filler nipple port for loading grease
- Positive-grip follower handle with locking tab
- Includes: 4-Jaw coupler for better grip and longer service life and 6 in. angled extension



L1310

Retail Pkg.



L1380

Retail Pkg.

L1380 - 12V Cordless Grease Gun Kit

FEATURES:

- Delivers up to 6,000 psi
- No manual pumping required
- Machined and hardened piston
- Cartridge and bulk loading
- Powerful 12V motor
- Planetary gear drive
- Plated steel barrel
- Includes: 30 in. flexible grease hose for hard-to-reach grease fittings, 1 hour quick-charger, two Ni-Cd rechargeable 12V batteries, shoulder strap and carrying case - durable case for long-lasting protection and storage



L1380-B

L1380-C

Part No.	Description
L1380-B	Replacement battery
L1380-C	Replacement battery charger

Workforce® Pro Grease Guns

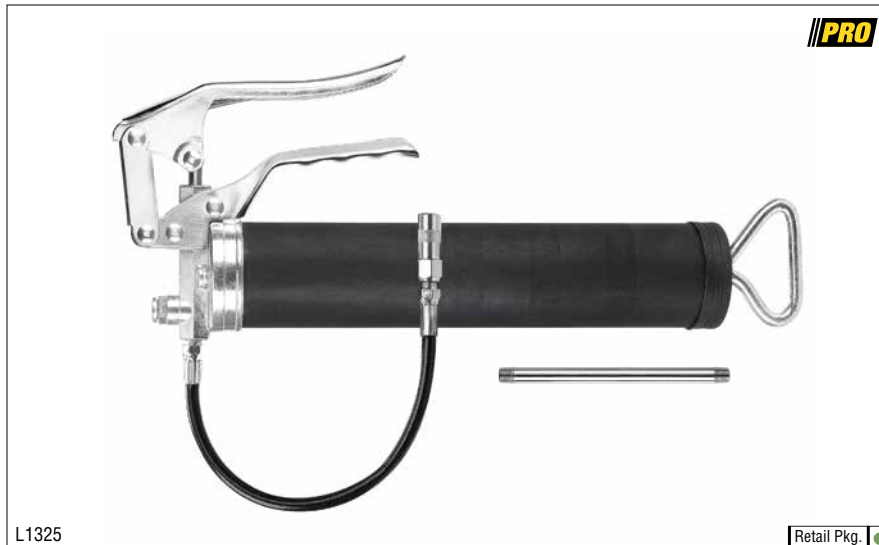

L1325 - Heavy-Duty Pistol Grip Grease Gun

FEATURES:

- Filler nipple port for loading grease
- Positive-grip follower handle
- Includes: 4-Jaw coupler for better grip and longer service life, 12 in. flexible grease hose and 6 in. straight extension



L1355 - Heavy-Duty Lever Action Grease Gun

FEATURES:

- Variable stroke allows grease delivery in confined areas where short strokes and high pressure on demand are needed
- Bleeder valve for purging unwanted air
- Positive-grip follower handle with locking tab
- Ergonomic lever grip
- 3-Way loading - Cartridge, bulk, filler nipple
- Includes: 4-Jaw coupler for better grip and longer service life, 12 in. flexible grease hose and 6 in. angled extension

Workforce® Suction Gun



L1700 - Suction Gun

FEATURES:

- Heavy-duty follower for positive suction
- Ergonomic grip follower handle
- Flexible vinyl hose for hard-to-reach areas
- Non-slip knurled barrel for better grip
- 16 oz. capacity

Workforce® Grease Couplers

Couplers

High pressure grease couplers for manual and air operated equipment. These couplers are equipped with 1/8 in. ends and hardened precision fit jaws for extended service life.

Part No.	Description	Pressure	Quick Connect Compatible	Retail Packaging
L2010	Workforce® Grease Coupler, 4-Jaw, Ball Check	6,000 psi	Yes	●
L2010-2PK	Workforce® Grease Coupler, 4-Jaw, Ball Check, 2-Pack	6,000 psi	Yes	●
L2015	Lock-n-Load™ Grease Coupler, 4-Jaw, High Pressure	10,000 psi	Yes	●
L2020	Workforce® Grease Coupler, 3-Jaw, High Pressure, Large Style	10,000 psi	No	●

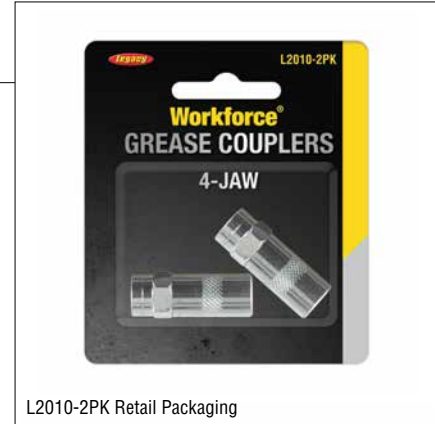

L2010-2PK Retail Packaging



L2010



L2015



L2020

Right Angle Couplers



L2162

L2162 - Grease Coupler, Low Profile

FEATURES:

- 90° grease coupler for low profile/high pressure greasing applications such as hard-to-reach grease fittings on cars, trucks and equipment
- Quick connect
- Ideal for lubrication of late model front wheel drive vehicles



L2163

Retail Pkg. ●

L2163 - Grease Coupler, Right Angle

FEATURES:

- Angle adapter specifically made for compact, subcompact and 4-wheel drive vehicles
- Quick connect
- Ideal for working in tight areas



L2040

Retail Pkg. ●

L2040 - Grease Coupler, Right Angle, Slide-on

FEATURES:

- Angle adapter specifically made for compact, subcompact and 4-wheel drive vehicles
- Ideal for working in tight areas

Workforce® Grease Couplers (continued)

Special Grease Couplers



L2100-1 - Grease Coupler, Needle-Point, Hypodermic Type

FEATURES:

- For boots or sealed bearings
- Includes a protective plastic cover
- 18 gauge needle
- For use with manual guns only



L2105 - Grease Coupler, Needle-Point, Hypodermic Type

FEATURES:

- For boots or sealed bearings
- Includes a protective plastic cover
- Quick connect
- 14 gauge needle
- For use with manual guns only



L2110 - Grease Coupler, Needle-Point, Straight Type

FEATURES:

- Allows operator to contact flush type or hard-to-reach hydraulic type fittings
- Threads 1/8 in. FNPT



L2120 - Grease Coupler, Needle-Point, Short

FEATURES:

- Needle type coupler for flush type or hard-to-reach fittings
- Quick connect



L2130 - Grease Coupler, Seal-Off/Rubber Tip

FEATURES:

- Used for lubricating cars with greasing plugs, spindles and U-Joints
- Threads 1/8 in. FNPT
- Oil and grease resistant rubber tip
- For use with manual guns only

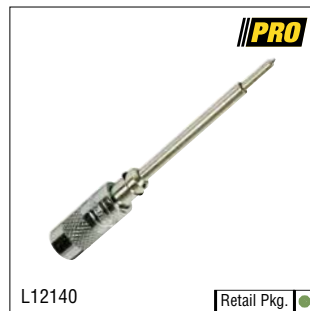

L21240 - Grease Coupler, 3 in. Needle-Point, Straight

FEATURES:

- Needle type coupler for flush type or hard-to-reach fittings
- Quick connect
- Ideal for 4-wheel drive vehicles
- Excellent on CV joints



L2144 - Grease Coupler, 3 in. Needle-Point, Right Angle

FEATURES:

- Needle type coupler for flush type or hard-to-reach fittings
- Quick connect
- Ideal for 4-wheel drive vehicles
- Excellent on CV joints

Workforce[®] Grease Couplers (continued)

Special Grease Couplers



**L2145 - Grease Coupler,
5 in. Needle-Point, Straight**

FEATURES:

- Needle type coupler for flush type or hard-to-reach fittings
- Quick connect
- Ideal for 4-wheel drive vehicles
- Excellent on CV joints



**L2165 - Grease Coupler,
6 in. Push-On, Straight**

FEATURES:

- Used to lubricate recessed fittings where obstructions will not permit use of hydraulic coupler
- Quick connect
- For use with manual guns only

Button Head Couplers



**L2305 - Standard Button
Head Grease Coupler**

FEATURES:

- Fits 5/8 in. button head grease fittings
- 4,000 psi maximum working pressure
- Quick connect

Workforce™ Grease Hoses

Standard-Duty Rubber Grease Hoses

FEATURES:

- SAE100R1 single steel wire braid grease hose with oil-resistant cover
- Operational Temp.: -40° to 190°F
- Heavy-duty, high quality 1/8 in. MNPT fittings
- For manual operated grease guns only

Part No.	Description	Hose I.D.	Hose Length	Working Pressure	Coupler	Spring Guard	Quick Connect Compatible	Retail Packaging
L2200	Grease Hose, 12 in. Steel Braid/Rubber	3/16 in.	12 in.	3,000 psi	NA	No	No	–
L2205	Grease Hose, 12 in. Steel Braid/Rubber, 4-Jaw Coupler	3/16 in.	12 in.	3,000 psi	4-Jaw	No	No	●
L2206-1	Grease Hose, 16 in. Steel Braid/Rubber, 4-Jaw Coupler, Quick Connect	3/16 in.	16 in.	3,000 psi	4-Jaw	No	Yes	●
L2210-1	Grease Hose, 18 in. Steel Braid/Rubber	3/16 in.	18 in.	3,000 psi	NA	No	No	●
L2220	Grease Hose, 24 in. Steel Braid/Rubber	3/16 in.	24 in.	3,000 psi	NA	No	No	–
L2230	Grease Hose, 36 in. Steel Braid/Rubber	3/16 in.	36 in.	3,000 psi	NA	No	No	–
L2235	Grease Hose, 36 in. Steel Braid/Rubber, 4-Jaw Coupler	3/16 in.	36 in.	3,000 psi	4-Jaw	No	No	–



Workforce™ Grease Hoses (continued)

Thermoplastic Grease Hoses

FEATURES:

- SAE100R7 thermoplastic grease hose
- 12,000 psi burst pressure
- Heavy-duty, high quality 1/8 in. MNPT fittings
- For manual operated grease guns only

Part No.	Description	Hose Length	Hose I.D.	Working Pressure	Coupler	Spring Guard	Retail Packaging
L2270-1	Grease Hose, 12 in. Thermoplastic	12 in.	1/8 in.	3,000 psi	NA	No	●
L2270SP-1	Grease Hose, 12 in. Thermoplastic Spring Guard	12 in.	1/8 in.	3,000 psi	NA	Yes	●
L2275-1	Grease Hose, 18 in. Thermoplastic	18 in.	1/8 in.	3,000 psi	NA	No	●
L2275SP-1	Grease Hose, 18 in. Thermoplastic, Spring Guard	18 in.	1/8 in.	3,000 psi	NA	Yes	●
L2285SP-1	Grease Hose, 36 in. Thermoplastic, Spring Guard	36 in.	1/8 in.	3,000 psi	NA	Yes	●
L2810SP-1	Lock-n-Load™ Grease Hose, 18 in. Thermoplastic, Spring Guard, High Pressure	18 in.	1/8 in.	10,000 psi	NA	Yes	●

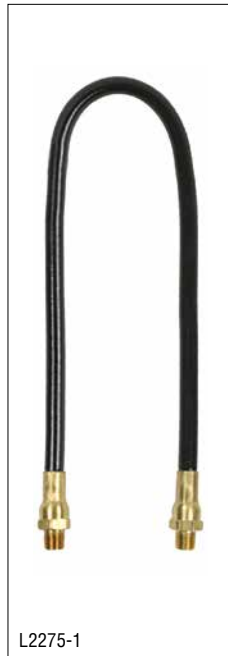

Workforce[®] Grease Accessories



GCB12

Retail Pkg.

GCB12 - Porta-Pak™ 12-Pack Grease and Caulk Tube Storage Box

FEATURES:

- Protected storage for 12 tubes of grease and/or caulk
- Adjustable shoulder strap
- Stores tubes in upright position
- Damage and weather-resistant
- Made with high-impact plastic construction
- Grease cartridges and caulk not included



L2440

Retail Pkg.

L2440 - Grease Extension, 6 in. Angled/Rigid

FEATURES:

- Thread size 1/8 in. MNPT



L2450

Retail Pkg.

L2450 - Grease Coupler, 3-Jaw, 360° Swivel

FEATURES:

- Grease Coupler, 3-Jaw, 360° Swivel
- Eight 45° locking positions
- Thread size 1/8 in. FNPT



L2461

Retail Pkg.

L2461 - Filler Nipple

FEATURES:

- Standard thread size 1/8 in. MNPT



L2470

Retail Pkg.

L2470 - Grease Gun Holder

FEATURES:

- Attach holder to workbench, pegboard or most any area designed for grease or suction guns with 2-1/4 in. OD barrels



L2475

Retail Pkg.

L2475 - Bearing Packer

FEATURES:

- Will pack any bearing up to 5 in. OD while forcing out old grease
- Can be used with any Legacy grease gun except the L1305

Workforce® Pro Lubrication Accessory Kits

The greasing accessory kits are designed for general purpose jobs. Housed in durable space saving carrying cases, the kits can be stored in the drawer of a tool chest. Each accessory has a dedicated compartment so the kits can be easily sight checked for missing pieces. All kit accessories are also sold separately.

Part No.	Description	Retail Packaging
L2550	7-Pc. General Purpose Grease Accessory Kit PRO	—
Includes:		
L2206SP	Grease Hose, 3/16 in. x 16 in. Steel Braid/Rubber, Spring Guard, 4-Jaw Coupler, Quick Connect	
L2105	Grease Coupler, Needle-Point, Hypodermic Type, Quick Connect	
L12140	Grease Coupler, 3 in. Needle-Point, Straight, Quick Connect	
L2144	Grease Coupler, 3 in. Needle-Point, Right Angle, Quick Connect	
L2160	Grease Coupler, Needle-Point, Right Angle, Quick Connect	
L2162	Grease Coupler, Low Profile, Quick Connect	
L2165	Grease Coupler, 6 in. Push-On, Straight, Quick Connect	

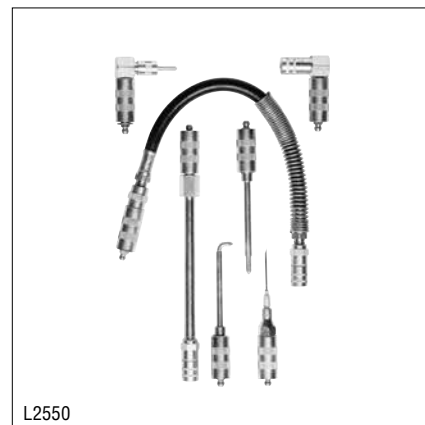

L2550

Part No.	Description	Retail Packaging
L2551	8-Pc. Automotive Grease Accessory Kit PRO	—
Includes:		
L2206SP	Grease Hose, 3/16 in. x 16 in. Steel Braid/Rubber, Spring Guard, 4-Jaw Coupler, Quick Connect	
L2105	Grease Coupler, Needle-Point, Hypodermic Type, Quick Connect	
L12140	Grease Coupler, 3 in. Needle-Point, Straight, Quick Connect	
L2144	Grease Coupler, 3 in. Needle-Point, Right Angle, Quick Connect	
L2160	Grease Coupler, Needle-Point, Right Angle, Quick Connect	
L2162	Grease Coupler, Low Profile, Quick Connect	
L2163	Grease Coupler, Right Angle, Quick Connect	
L2165	Grease Coupler, 6 in. Push-On, Straight, Quick Connect	



L2551

Part No.	Description	Retail Packaging
L2560	10-Pc. Heavy-Duty Contractor Grease Accessory Kit PRO	—
Includes:		
L2216SP	Grease Hose, 3/16 in. x 16 in. Steel Braid/Rubber, Spring Guard, 4-Jaw Coupler, Quick Connect	
L2105	Grease Coupler, Needle-Point, Hypodermic Type, Quick Connect	
L12140	Grease Coupler, 3 in. Needle-Point, Straight, Quick Connect	
L2144	Grease Coupler, 3 in. Needle-Point, Right Angle, Quick Connect	
L2160	Grease Coupler, Needle-Point, Right Angle, Quick Connect	
L2162	Grease Coupler, Low Profile, Quick Connect	
L2165	Grease Coupler, 6 in. Push-On, Straight, Quick Connect	
L2305	Standard Button Head Grease Coupler, Quick Connect	
L5960	All-In-One Repair Tool, 1/4 in. - 28 Fittings	
L5970	All-In-One Repair Tool, 1/8 in. NPT Fittings	



L2560

Workforce® Standard Grease Fittings

1/4 Inch - 28 Thread

Part No.	Description	Retail Packaging
L5001	Grease Fittings, 1/4 in. - 28 Straight, 10-Pc.	●
L5031	Grease Fittings, 45° 1/4 in. - 28 Straight, 10-Pc.	●
L5041	Grease Fittings, 90° 1/4 in. - 28 Straight, 10-Pc.	●

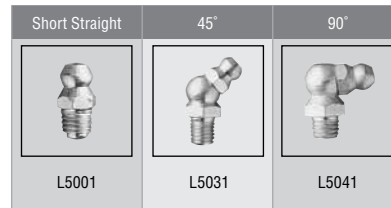

1/8 Inch National Pipe Thread

Part No.	Description	Retail Packaging
L5211	Grease Fittings, 1/8 in. Straight PTF, 10-Pc.	●
L5221	Grease Fittings, 45° 1/8 in. PTF, 10-Pc.	●
L5251	Grease Fittings, 90° 1/8 in. PTF, 10-Pc.	●



Workforce® Metric Grease Fittings

Part No.	Description	Retail Packaging
L5401	Grease Fittings, Metric, 6mm. x 1 Straight, 5-Pc.	●
L5501	Grease Fittings, Metric, 8mm. x 1 Straight, 5-Pc.	●
L5701	Grease Fittings, Metric, 10mm. x 1 Straight, 5-Pc.	●

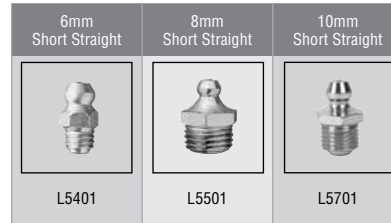

Workforce® Drive Type Grease Fittings

3/16, 1/4 and 5/16 Inch

Part No.	Description – 3/16 In.	Retail Packaging
L5601	Grease Fittings, Drive Type, 3/16 in. Straight, 10-Pc.	●
	Description – 5/16 In.	
L5621	Grease Fittings, Drive Type, 5/16 in. Straight, 10-Pc.	●



Workforce® Grease Fitting Assortments

Standard and Metric



L5900 - Grease Fitting Assortment, Standard, 8-Pc.

FEATURES:

- 3 most common fittings for domestic and foreign cars and trucks, comes in a clam-pack container



L5950 - Grease Fitting Assortment, Standard, 96-Pc.

FEATURES:

- 6 most popular 1/4 in. - 28 and 1/8 in. MNPT fitting sizes contained in a refillable plastic box



L5910 - Grease Fitting Assortment, Metric, 8-Pc.

FEATURES:

- 6 mm. assortment contains most common fittings used when replacing damaged fittings or converting from plugs, comes in a clam-pack container



L5990 - Grease Fitting Assortment, Metric, 96-Pc.

FEATURES:

- 9 most popular 6 mm., 8mm. and 10 mm. fitting sizes contained in a refillable plastic box

Part No.	Description - Standard	Contents			Retail Packaging
L5900	Grease Fitting Assortment - Standard 8-Pc.	4 - 1/4 in. - 28, Short Straight	2 - 1/4 in. - 28, 45°	2 - 1/4 in. - 28, 90°	●
L5950	Grease Fitting Assortment - Standard 96-Pc.	24 - 1/4 in. - 28, Short Straight 24 - 1/8 in. NPT, Short Straight	12 - 1/4 in. - 28, 45° 12 - 1/8 in. NPT, 45°	12 - 1/4 in. - 28, 90° 12 - 1/8 in. NPT, 90°	●
Part No.	Description - Metric	Contents			
L5910	Grease Fitting Assortment - Metric 8-Pc.	4 - M6 x 1 Thread, Short Straight	2 - M6 x 1 Thread, 45°	2 - M6 x 1 Thread, 90°	●
L5990	Grease Fitting Assortment - Metric 96-Pc.	40 - M6 x 1 Thread, Straight 10 - M8 x 1 Thread, Straight 10 - M10 x 1 Thread, Straight	6 - M6 x 1 Thread, 45° 6 - M8 x 1 Thread, 45° 6 - M10 x 1 Thread, 45°	6 - M6 x 1 Thread, 90° 6 - M8 x 1 Thread, 90° 6 - M10 x 1 Thread, 90°	●

Workforce® Grease Fitting Repair Tools



L5960

Retail Pkg.

L5960 - All-In-One Repair Tool, 1/4 in. - 28

FEATURES:

- Re-taps 1/4 in. - 28 threads
- Installs 5/16 in. and 3/8 in. hex straight or angle-type fittings
- Removes 5/16 in. and 3/8 in. hex straight or angle-type fittings
- “Easy-out” removes broken 1/4 in. NPT fittings



L5970

Retail Pkg.

L5970 - All-In-One Repair Tool, 1/8 in. NPT Fittings

FEATURES:

- Re-taps 1/8 in. NPT threads
- Installs 7/16 in. and 3/8 in. hex straight or angle-type fittings
- Removes 7/16 in. and 3/8 in. hex straight or angle-type fittings
- “Easy-out” removes broken 1/8 in. NPT fittings

Workforce® Manual Grease Transfer Pump Accessories

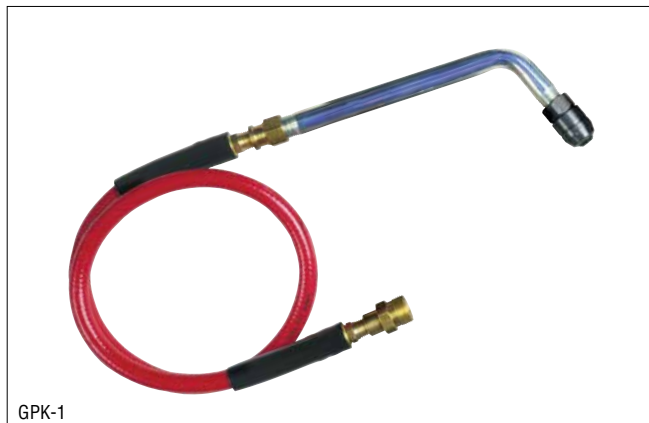

GPK-1

GPK-1 - Grease Transfer and Loading Kit is designed to load grease into Legacy™ part number ML7 MEGA LUBE® refillable container grease guns with a filler nipple. Compatible with Legacy L3065 grease transfer pumps.



GPK-2

GPK-2 - Two-Way Use Bearing Packer for packing grease into bearings. Quickly attach the GPK-2 to the L3065 grease transfer pump using the pump's quick connect feature.

FEATURES:

- The GPK-2 is compatible with the L3065 quick connect system, allowing it to be connected and disconnected with ease
- Packs bearings up to 6 in. diameter
- Includes heavy-duty dust cover

Performance™ Series Greasing Systems and Grease Pumps

Used in either mobile or stationary systems for grease distribution, these versatile high-pressure grease pumps can handle most types of mineral and synthetic greases up to and including NLGI 2. Performance™ Series grease pumps are built for corrosion-resistance using aluminum and alloy steel, with nylon, PTFE, and nitrile seals for longer life and trouble-free operation. Backed by outstanding service and a 5-year extended warranty, you can't buy more reliable and efficient pumps.



L6000

L6000 - 35 lb. container - indoor applications

System Components	
Part No.	Description
L6005	55:1 ratio grease pump for 35 lb. pail
DC5	Lid for 35 lb. pails
DD5	Drum Dolly for 35 lb. pail
LCG1-01	Booster Gun with "Z" swivel
GFP1	Universal follower plate for tapered or straight 35 lb. pails
LH1414414	12 ft. high pressure grease hose with 1/4 in. MNPT ends
Parts also sold separately	



L6100

L6100 - 120 lb. keg - indoor applications

System Components	
Part No.	Description
L6105	55:1 ratio grease pump for 120 lb. keg
DC16	Lid for 120 lb. keg
DD16	Drum Dolly for 120 lb. keg
LCG1-01	Booster Gun with "Z" swivel
GFP2	Universal follower plate for 120 lb. keg
LH1414414	12 ft. high pressure grease hose with 1/4 in. MNPT ends
Parts also sold separately	



L6005

L6005 - Standard Features:

- For 35 lb. standard or tapered grease containers
- Pumps include height-adjusting bung adapter for mounting on drum covers with 2 in. bung opening
- Ideal for use with indoor mobile and stationary equipment

Pump Specifications for L6005	
Pump Ratio	55:1
Average Air Consumption at 100 PSI:	5 CFM (.14 m ³ /min)
Min Air Inlet Pressure:	40 psi (3 bar)
Max Air Inlet Pressure:	140 psi (10 bar)
Air Inlet Thread:	1/4 in. FNPT
Product Outlet Thread Size:	1/4 in. FNPT
Max Viscosity:	NLGI #2
Max Free Flow Rate (Fluid Output/Min at Pump):	22 fl. oz./min. (650 ml/min.)
Air Piston Diameter:	3 in.
Piston Stroke:	1-1/2 in.
Operating Air Pressure Range:	60 - 120 psi

Drum Dollies

Legacy™ drum dollies incorporate a superior design placing the casters outside the drum for greater load stability and longer service life. (DD5 and DD16 only)

Part No.	Container Size	Capacity	Caster Diameter
DD5	5 gal.	35 lbs.	2 in.
DD16	16 gal.	120 lbs.	2 in.
DD55	55 gal.	400 lbs.	3 in.

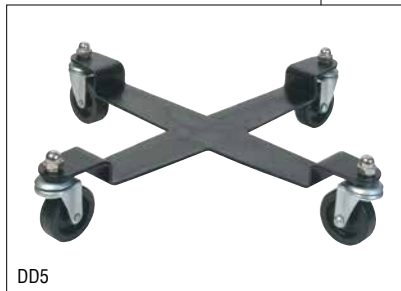

DD5



DD16



DD55

Performance™ Series Control Guns

- Rugged all-steel construction
- Heavy-duty 4-Jaw coupler
- Ergonomic design for ease of operation
- Z-Swivel with 1/4 in. FNPT x 1/8 in. MNPT threads (*LCG1-01 ONLY*)
- 1/8 in. FNPT inlet
- Positive-grip handle
- 6 in. extension

Part No.	Description
LCG1	Control gun with booster feature
LCG1-01	Control gun with booster feature and 360° Z-Swivel

Can easily boost greasing pressure to over 10,000 psi on demand



LCG1



LCG1-01

Z-Swivel

LCZ - Z-Swivel for Grease Control Guns

- 360° Z-Swivel for easy rotation
- 1/4 in. FNPT x 1/8 in. MNPT



LCZ

Manual Grease Transfer Pumps

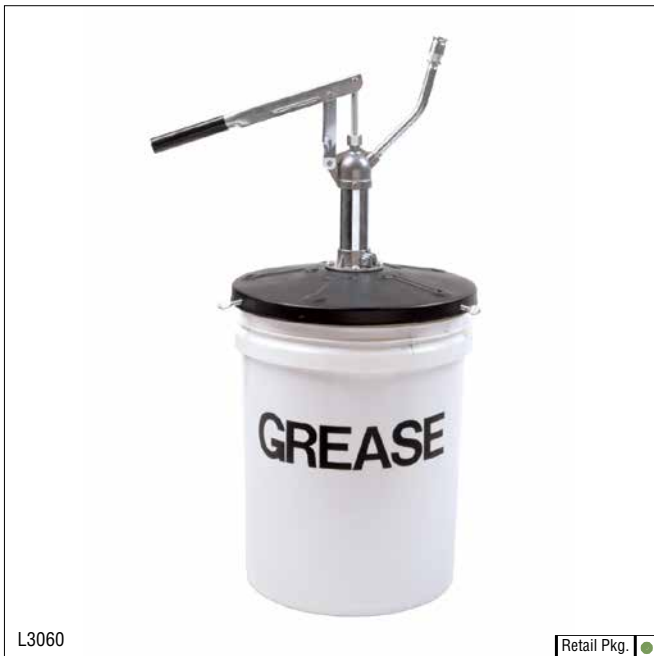

L3060 - Transfer Pump is designed to bulk load grease guns from 35 lb. grease pails.

FEATURES:

- Complete with pail cover and follower plate
- Dispenses 2.13 oz. per stroke
- For 35 lb. bucket
- Loader nipple to fit any grease gun with bulk filling capability
- Dust cover for filler nipple
- Most economical way to fill hand grease guns



L3065 - Transfer Pump is designed to fit a 35 lb. pail in order to fill grease guns equipped with a grease filler nipple. The quick-connect adapter will accept the following GPK grease transfer and loading attachments:

- GPK-1 (sold separately)
- GPK-2 (sold separately)

FEATURES:

- Complete with pail cover and follower plate
- Dispenses 2.13 oz. per stroke
- For 35 lb. bucket
- Loader nipple to fit any grease gun with bulk filling capability
- Dust cover for filler nipple
- Most economical way to fill hand grease gun
- Includes: Rubber-lipped follower for use with tapered grease pails and screw type quick disconnect socket and plug 1/4 in. NPT

Oil Pumping Equipment

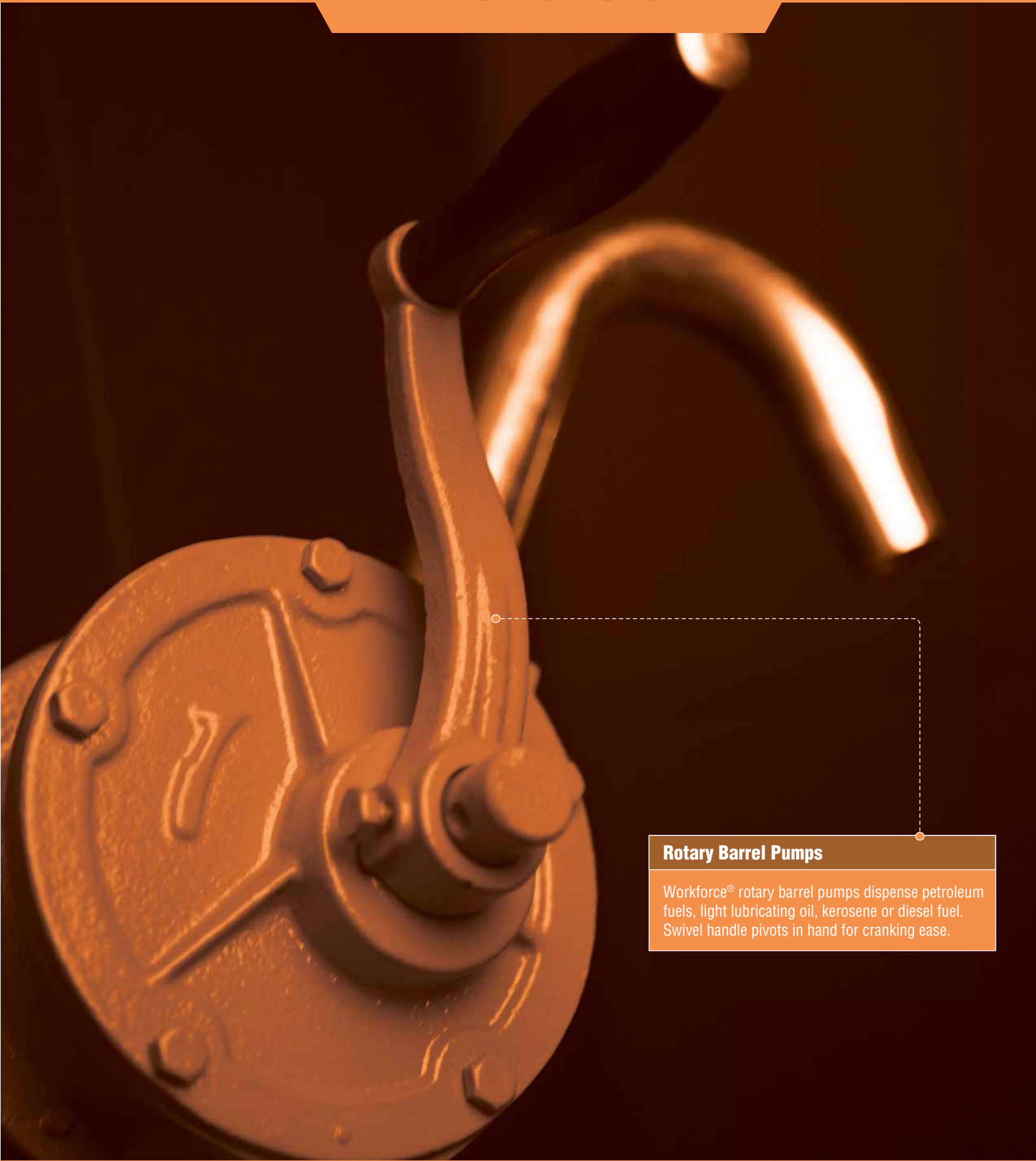

Rotary Barrel Pumps

Workforce® rotary barrel pumps dispense petroleum fuels, light lubricating oil, kerosene or diesel fuel. Swivel handle pivots in hand for cranking ease.

Performance™ Series Air-Operated Oil Pumps

All Performance™ Series pumps use components made from high quality alloy materials for lasting durability. Performance Series air-operated oil pumps fit almost any kind of container, run quietly and are available separately or in several different systems - all equipped to meet general or specific oil transfer applications. Note: Containers are not included.



L3510

FEATURES:

- High volume transfer pump
- Not for pumping flammable materials or waste oil
- Wetted pump components: aluminum, steel, PTFE, nitrile, polyurethane, nylon
- Ideal for transferring oil through short runs with small pressure drops
- Stub pump design provides the versatility to transfer and dispense controlled amounts of lubricant using an oil spigot, control valve or meter
- For indoor applications only

Specifications:	
Pump Ratio	1:1
Avg. Air Consumption @ 100 psi	7 CFM (.20 m ³ /min)
Air Inlet Thread	1/4 in. FNPT
Fluid Inlet Thread Size	1 in. FNPT
Fluid Outlet Thread Size	3/4 in. FNPT **
Max Viscosity	SAE 140 (ISO 680)
Max Free Flow Rate (Fluid Output/Min at Pump) *	14 GPM (52.8 liters/min)
Min/Max Air Inlet Pressure	40/140 psi (2.7/10 bar)

*Free delivery, SAE 30 oil at 70°F (20°C) - Air Press. 100 psi (7 bar)

**Includes 3/4 in. MNPT x 1/2 in. FNPT Steel Bushing



L3530

FEATURES:

- Medium volume transfer pump
- Not for pumping flammable materials or waste oil
- Wetted pump components: aluminum, steel, PTFE, nitrile, polyurethane, nylon
- For use in oil distribution systems comprised of pipelines and/or hose reels and fluid meters
- For portable and stationary systems
- For indoor applications only

Specifications:	
Pump Ratio	1:1
Avg. Air Consumption @ 100 psi	7 CFM (.20 m ³ /min)
Air Inlet Thread	1/4 in. FNPT
Fluid Inlet Thread Size	1 in. FNPT
Fluid Outlet Thread Size	3/4 in. FNPT **
Max Viscosity	SAE 140 (ISO 680)
Max Free Flow Rate (Fluid Output/Min at Pump) *	14 GPM (52.8 liters/min)
Min/Max Air Inlet Pressure	40/140 psi (2.7/10 bar)

*Free delivery, SAE 30 oil at 70°F (20°C) - Air Press. 100 psi (7 bar)

**Includes 3/4 in. MNPT x 1/2 in. FNPT Steel Bushing

Performance™ Series Air-Operated Oil Pumps (continued)

All Performance™ Series pumps use components made from high quality alloy materials for lasting durability. Performance Series air-operated oil pumps fit almost any kind of container, run quietly and are available separately or in several different systems - all equipped to meet general or specific oil transfer applications. Note: Containers are not included.



L3553

FEATURES:

- Heavy-duty medium volume pump
- Not for pumping flammable materials or waste oil
- Wetted pump components: aluminum, steel, PTFE, nitrile, polyurethane, nylon
- Ideal for distribution systems with long pipelines and/or hose reels and fluid meters
- High volume delivery allows this pump to serve several outlets simultaneously
- For indoor applications only

Specifications:	
Pump Ratio	5:1
Avg. Air Consumption @ 100 psi	7 CFM (.20 m ³ /min)
Air Inlet Thread	3/8 in. FNPT
Fluid Inlet Thread Size	3/4 in. FNPT
Fluid Outlet Thread Size	3/4 in. FNPT **
Max Viscosity	SAE 140 (ISO 680)
Max Free Flow Rate (Fluid Output/Min at Pump) *	6.6 GPM (25 liters/min)
Min/Max Air Inlet Pressure	40/140 psi (2.7/10 bar)

*Free delivery, SAE 30 oil at 70°F (20°C) - Air Press. 100 psi (7 bar)

**Includes 3/4 in. MNPT x 1/2 in. FNPT Steel Bushing



L3510K

FEATURES:

- High volume transfer pump
- Ideal for transferring oil through short runs with small pressure drops
- Wetted pump components: aluminum, steel, PTFE, nitrile, polyurethane, nylon. Telescoping suction tube is steel
- Not for pumping flammable materials or waste oil
- Telescoping suction tube included, to fit tanks 39 in. to 60 in. deep. (3/4 in. MNPT x 1 in. FNPT bushing included)
- For indoor applications only

Specifications:	
Pump Ratio	1:1
Avg. Air Consumption @ 100 psi	7 CFM (.20 m ³ /min)
Air Inlet Thread	1/4 in. FNPT
Fluid Inlet Thread Size	1 in. FNPT
Fluid Outlet Thread Size	3/4 in. FNPT **
Max Viscosity	SAE 140 (ISO 680)
Max Free Flow Rate (Fluid Output/Min at Pump) *	14 GPM (52.8 liters/min)
Min/Max Air Inlet Pressure	40/140 psi (2.7/10 bar)

*Free delivery, SAE 30 oil at 70°F (20°C) - Air Press. 100 psi (7 bar)

**Includes 3/4 in. MNPT x 1/2 in. FNPT Steel Bushing

Performance™ Series Air-Operated Oil Pumps (continued)

All Performance™ Series pumps use components made from high quality alloy materials for lasting durability. Performance Series air-operated oil pumps fit almost any kind of container, run quietly and are available separately or in several different systems - all equipped to meet general or specific oil transfer applications. Note: Containers are not included.



L3530K

FEATURES:

- Medium volume pump
- For use in oil distribution systems comprised of pipelines and/or hose reels and fluid meters
- For portable and stationary systems
- Wetted pump components: aluminum, steel, PTFE, nitrile, polyurethane, nylon. Telescoping suction tube is steel
- Not for pumping flammable materials or waste oil
- Telescoping suction tube included, to fit tanks 39 in. to 60 in. deep. (3/4 in. MNPT x 1 in. FNPT bushing included)
- For indoor applications only

Specifications:	
Pump Ratio	3:1
Avg. Air Consumption @ 100 psi	5 CFM (.14 m ³ /min)
Air Inlet Thread	1/4 in. FNPT
Fluid Inlet Thread Size	3/4 in. FNPT
Fluid Outlet Thread Size	3/4 in. FNPT **
Max Viscosity	SAE 140 (ISO 680)
Max Free Flow Rate (Fluid Output/Min at Pump) *	9.25 GPM/ (35 liters/min)
Min/Max Air Inlet Pressure	40/140 psi (2.7/10 bar)

*Free delivery, SAE 30 oil at 70°F (20°C) - Air Press. 100 psi (7 bar)

**Includes 3/4 in. MNPT x 1/2 in. FNPT Steel Bushing



L3553K

FEATURES:

- Heavy-duty medium volume pump
- Ideal for distribution systems with long pipelines and/or hose reels and fluid meters
- High volume delivery allows this pump to serve several outlets simultaneously
- Wetted pump components: aluminum, steel, PTFE, nitrile, polyurethane, nylon. Telescoping suction tube is steel
- Not for pumping flammable materials or waste oil
- Telescoping suction tube included, to fit tanks 39 in. to 60 in. deep. (3/4 in. MNPT x 1 in. FNPT bushing included)
- For indoor applications only

Specifications:	
Pump Ratio	5:1
Avg. Air Consumption @ 100 psi	7 CFM (.20 m ³ /min)
Air Inlet Thread	3/8 in. FNPT
Fluid Inlet Thread Size	3/4 in. FNPT
Fluid Outlet Thread Size	3/4 in. FNPT **
Max Viscosity	SAE 140 (ISO 680)
Max Free Flow Rate (Fluid Output/Min at Pump) *	6.6 GPM/ (25 liters/min)
Min/Max Air Inlet Pressure	40/140 psi (2.7/10 bar)

*Free delivery, SAE 30 oil at 70°F (20°C) - Air Press. 100 psi (7 bar)

**Includes 3/4 in. MNPT x 1/2 in. FNPT Steel Bushing

Oil Control Guns

Performance™ Series Electronically Metered Oil Control Guns



LCG90111 & LCG90112 Electronically Metered

COMMON FEATURES:

- Meter (Model LCGA9000)
 - Positive displacement digital meter
 - Push-button design for easy field recalibration
 - Low battery indicator
 - Meter is accurate to within +/- 0.5%
- Gun
 - High-pressure valve body
 - Ergonomic design
- Max. flow rate 2.9 GPM
- Trigger guard and safety lock to prevent accidental dispensing
- Excellent trigger feathering feature

LCG90111 GUN SPECIFIC FEATURES:

- Angled rigid extension
- Ideal for motor oil

LCG90112 GUN SPECIFIC FEATURES:

- 14 in. flexible extension
- Ideal for automatic transmission fluid

Performance™ Series Electronically Preset Metered Oil Control Guns



LCG92511 & LCG92512 Electronically Preset Metered

Specifications for LCG92511 and LCG92512	
Maximum Flow*	8 gpm
Minimum Flow*	0.25 gpm
Max. Operating Pressure	1,000 psi
Min. Operating Pressure	5 psi
Max. Operating Temp.	120°F
Min. Operating Temp.	20°F
Accuracy - Oils	+/- 0.5%
Accuracy - Antifreeze	+/- 1.5%
5-Digit LCD Display (10mm H x 5mm W)	Pints, Quarts, Gallons, Liters
Inlet and Outlet Connections	1/2 in. NPT

* Tested with DTE-25 motor oil at ambient temperature.
Min.-Max. flow range will vary with fluid viscosity.

Oil Control Guns (continued)

Oil Control Handle with Manual Non-Drip Nozzle

LCG90001

FEATURES:

- LCG90001 - Angled rigid extension with manual non-drip nozzle
- Heavy-duty control handle
- 1/2 in. FNPT inlet swivel
- Rated at 2,000 psi operating pressure
- Trigger guard and safety lock to prevent accidental dispensing
- Max. flow rate of 4.4 GPM
- Flexible extension version (LCG90002) available separately



LCG90001

ACCESSORIES:

Manual Non-Drip Nozzle

- Manually operated shut-off valve helps to eliminate waste and oily messes when not in use
- 3/8 in. FNPT
- 0.28 in. nozzle opening



LCGA9020

Workforce® Manual Transfer Pumps - Rotary Action

L3300 - Rotary Barrel Pump

FEATURES:

- Heavy-duty cast iron body
- Dispenses petroleum fuel oils, kerosene or diesel fuel
- Fits 16-55 gallon drums with 2 in. bung opening
- Dispenses 10 gallons per minute
- Includes: Inlet tube strainer/filter



L3300

Retail Pkg.

L3350 - Rotary Pump

Ideal for evacuating waste oil drains. This hand operated rotary pump is suitable for delivering kerosene, diesel, lubricants, edible oils and other non-corrosive liquids.

FEATURES:

- Heavy-duty cast iron body
- Dispenses 14.8 qts. (3.7 gallons) per minute
- 2 in. bung adapter
- Includes: 3/4 in. x 3 ft. steel suction tube, 4 ft. hose, curved discharge spout and nozzle



L3350

Workforce® Manual Oil Transfer Pumps - Lever Action

Workforce® manual barrel pumps are ideal for oil, antifreeze and chemical transfer. Workforce barrel pumps feature rotary, lift and lever action styles ideal for automotive and industrial jobs.

Note: Pumps not for use with food products or water. For fluid lubricants, solvents, thinners, automotive additives, chemicals and non-corrosive liquids.



L3000 and L3100 - Lever Action Barrel Pumps

FEATURES:

- Die-cast head with steel piston and brass segments which assures long life and durability
- Fits 16-55 gallon drums with standard 2 in. bung openings
- Telescopic suction tube dispenses petroleum-based fluids
- Curved discharge spout with garden hose threads
- Dispenses 10 oz. per stroke

L3100 FEATURE:

- Viton® seals are ideal for pumping alcohols, detergents, solvents and antifreeze



L3050 - Lever Action Oil Transfer Pump

FEATURES:

- Fits 5 gallon pail (pail not included)
- Dispenses 2.13 oz. per stroke
- Suitable for light, medium and heavy petroleum products
- Includes: Pail cover, 5 ft. clear vinyl hose and nozzle



L3115 - Multi Purpose Pump

FEATURES:

- Dispenses diesel fuel, kerosene, oils up to SAE 90, and more
- Telescopic suction tube fits 16-55 gallon drums
- 4 ft. fuel resistant hose with metal nozzle and nozzle holder
- Pumps 0.26 gallons per stroke
- Variable handle setting for light or heavy fluids
- Built-in bung opener on pump head
- Nozzle holder

Workforce® Manual Oil Transfer Pumps - Lift Action



L3200 - Lift Action Barrel Pump

FEATURES:

- Dispenses petroleum based and non-corrosive fluids
- Fits 16-55 gallon drums with 2 in. bung openings
- Removable curved steel spout with garden hose threads
- Zinc plated steel drum pump
- Steel tube and piston with buna-n seals
- Spout rotates 360° for non-drip feature
- Delivers 22 oz. per stroke



L3275 - Marine Lower Unit Flush and Fill Pump

FEATURES:

- Comes with an adapter for adding fluids to marine lower units
- Fits standard quart-sized bottles
- Includes flexible hose for hard-to-reach plugs 3/8 in. - 16 threaded filler fitting for Evinrude, Force, Gamefisher, Johnson, Mercruiser, OMC, Volvo and Honda 70-90 hp outboards

Air Hoses and Reels

- Items Shown:**
- Gondula Mounted Hose Reel Display Rack (HR-20)
 - Air Hoses
 - Air Hose Reels



SmartFlex® Air, Garden & RV/Marine Hoses

Items Shown:

- Air Hoses
- Air Hose Kits
- RV/Marine Hoses
- Garden Hoses

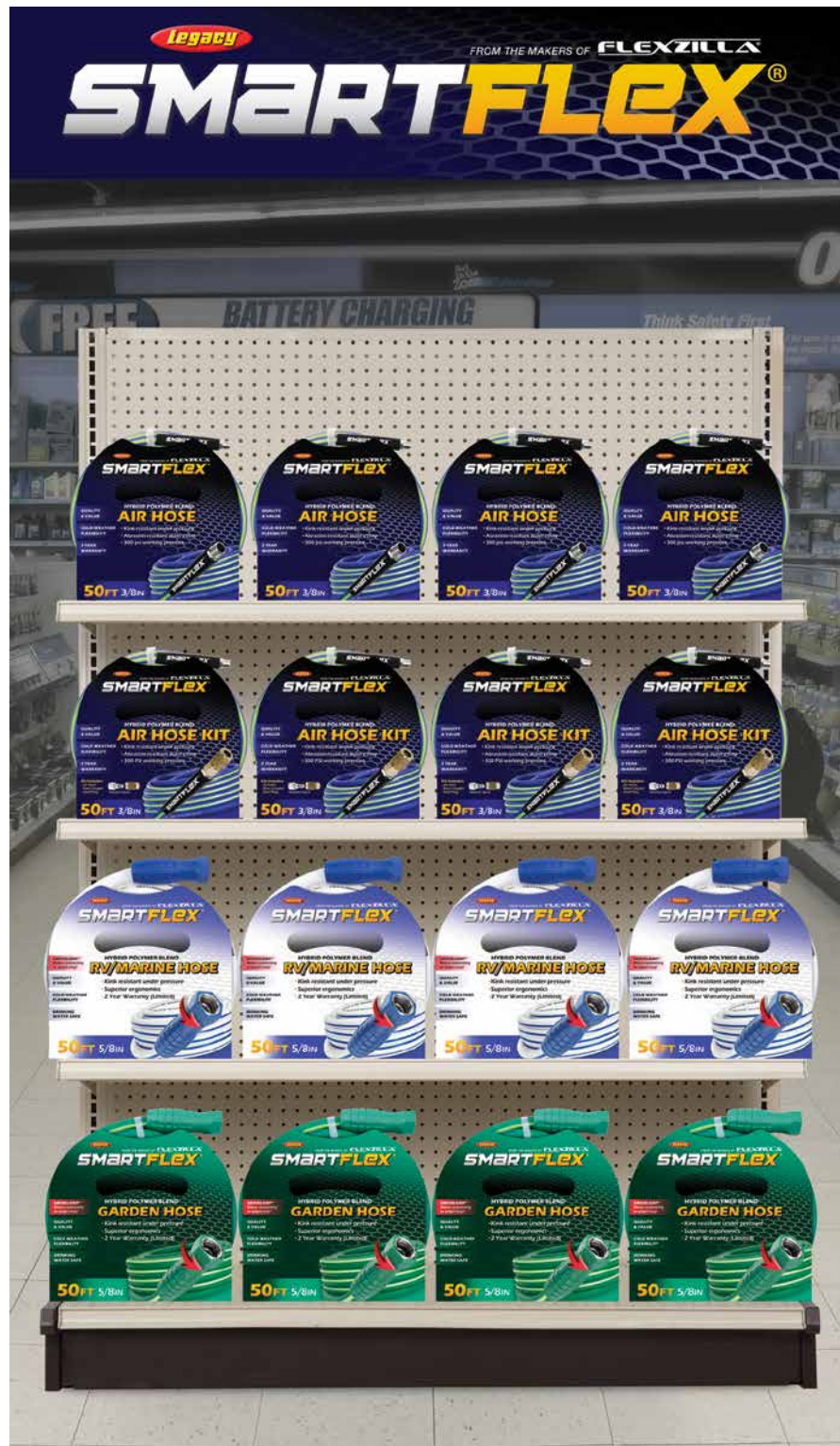

ColorConnex® Couplers, Plugs & Kits

Items Shown:

- ColorConnex Couplers, Plugs & Kits
 - Industrial (Type D): Red
 - Automotive (Type C): Blue
 - ARO (Type B): Green



Lock-n-Load™ & Workforce® Greasing Equipment

Items Shown:

- Grease Fittings
- Large Style Couplers
- 4-Jaw Couplers
- Grease Fitting Kits
- Grease Extensions
- Needle Point Couplers
- 3-Jaw Couplers
- Grease Gun Brackets
- Grease Fitting Repair Tools
- Grease Couplers
- Grease Whip Hoses
- Bearing Packers
- Workforce Grease Guns
- Lock-n-Load Grease Guns



Part No.	Pg.
A1640ABS-X	28
A5	17
A71410B	25
A71410B-X	25
A71410-X	25
A71416B	25
A71416B-X	25
A71420B	25
A71420B-X	25
A71426B	25
A71430B-2PK	25
A71430B-X	25
A71440B-2PK	25
A71440B-8PK	26
A71440B-X	25
A71440-X	25
A71452B	26
A71456B	26
A71457B	26
A71458B	26
A72410C	23
A72410C-X	23
A72416C	23
A72416C-X	23
A72420C	23
A72420C-X	23
A72426C	23
A72430C-2PK	23
A72430C-X	23
A72440C-2PK	23
A72440C-8PK	24
A72440C-X	23
A72440-X	23
A72452C	24
A72456C	24

Part No.	Pg.
A72457C	24
A72458C	24
A72630C-X	23
A72640C-X	23
A73410D	20
A73410D-X	20
A73410-X	20
A73415-X	20
A73416D	20
A73416D-X	20
A73420D	20
A73420D-X	20
A73420H-X	20
A73420-X	20
A73425-X	20
A73426D	20
A73426D-X	20
A73430D-2PK	21
A73430D-X	21
A73430-X	21
A73435-X	21
A73440D-2PK	21
A73440D-8PK	22
A73440D-X	21
A73440H-X	21
A73440-X	21
A73445-X	21
A73452D	22
A73456D	22
A73457D	22
A73458D	22
A73610-X	20
A73620H-X	20
A73620-X	20
A73640H-X	21

Part No.	Pg.
A74410-X	20
A75810-X	20
A75830-X	21
A77410-X	28
A77415	28
A77420-X	28
A84444-D	27
A84444-X	27
A94444DC-X	27
A94444-X	27
A9700-X	28
A9701-X	28
A9702-X	28
AG206	33
AG2-10	33
AG218	33
AG4-10	33
AG7	33
AG7B	33
AG7C	33
AG7D	33
AG9-X	33
AGKIT	33
AL2010	31
AL2050	31
AL3000	31
AL3010	31
AL3025	31
DD16	51
DD5	51
DD55	51
GCB12	45
GPK-1	49
GPK-2	49
HGH1	17

Part No.	Pg.
HGH2	17
HL23850F02-A02	16
HR-20	61
HRE1225RD3	17
HRE1250RD3	17
HRE1425RD2	17
HRE1450RD2	17
HRE3825RD2	17
HRE3835RD2	17
HRE3850RD2	17
HSF14100BL2	14
HSF14100BL2-I	14
HSF1450BL2	14
HSF1450BL2-I	14
HSF38100BL2	14
HSF38100BL2-I	14
HSF3825BL2	14
HSF3825BL2-I	14
HSF3850BL2	14
HSFG5100GR	15
HSFG550GR	15
HSFG575GR	15
HSFRV425	15
HSFRV450	15
HSFRV525	15
HSFRV550	15
HWF1250BL3	16
HWF1404RD2	16
HWF1425RD2	16
HWF3805RD2B	16
HWF3825BL2	16
HWF3825F02	16
HWF3825RD2	16
HWF3850BL2	16
HWF3850F02	16

Part Number Index

Part No.	Pg.
HWF3850RD2	16
HWF3850YW2	16
L1045L	36
L1075L	36
L12140	41, 46
L1305	38
L1310	38
L1325	39
L1355	39
L1380	38
L1380-B	37, 38
L1380-C	37, 38
L1380L	37
L1455L	37
L1466L	37
L1700	39
L2010	40
L2010-2PK	40
L2015	40
L2020	40
L2040	40
L2100-1	41
L2105	41, 46
L2110	41
L2130	41
L2144	41, 46
L2145	42
L2162	40, 46
L2163	40
L2165	40, 46
L2200	43
L2205	43
L2206-1	43
L2210-1	43
L2220	43

Part No.	Pg.
L2230	43
L2235	43
L2270-1	44
L2270SP-1	44
L2275-1	44
L2275SP-1	44
L2285SP-1	44
L2305	42, 46
L2440	45
L2450	45
L2470	45
L2475	45
L2550	46
L2551	46
L2560	46
L2810SP-1	44
L3000	59
L3050	59
L3060	52
L3065	52
L3115	59
L3200	60
L3275	60
L3300	59
L3350	59
L3510	54
L3510K	55
L3530	54
L3530K	56
L3553	55
L3553K	56
L5001	47
L5031	47
L5041	47
L5211	47

Part No.	Pg.
L5221	47
L5251	47
L5401	47
L5501	47
L5601	47
L5621	47
L5701	47
L5900	47
L5910	47
L5950	47
L5960	46, 49
L5970	46, 49
L5990	47
L6000	50
L6005	50
L6100	50
L8300-B	9
L8300-W	9
L8305	7, 8
L8305LI	9
L8305LI-10	9
L8306	7, 8
L8310	7, 8
L8335	7, 8
L8335LI	9
L8335LI-10	9
L8344	7, 8
L8345	7, 8
L8346	7, 8
L8349	7, 8
L8349LI	9
L8349LI-10	9
L8350	7, 8
L8550	11
L8560	11

Part No.	Pg.
L8611	10
L8621	10
L8631	10
L8632	10
L8641	10
L8650	12
L8652	12
LCG1	51
LCG1-01	51
LCG90001	58
LCG90002	58
LCG90111	57
LCG90112	57
LCG92511	57
LCG92512	57
LCGA9020	58
LCZ	51
TH0300	30
TH0301	30
TH0306	30
TH0307	30
TH0311	30
TH0317	30
TH0330	30

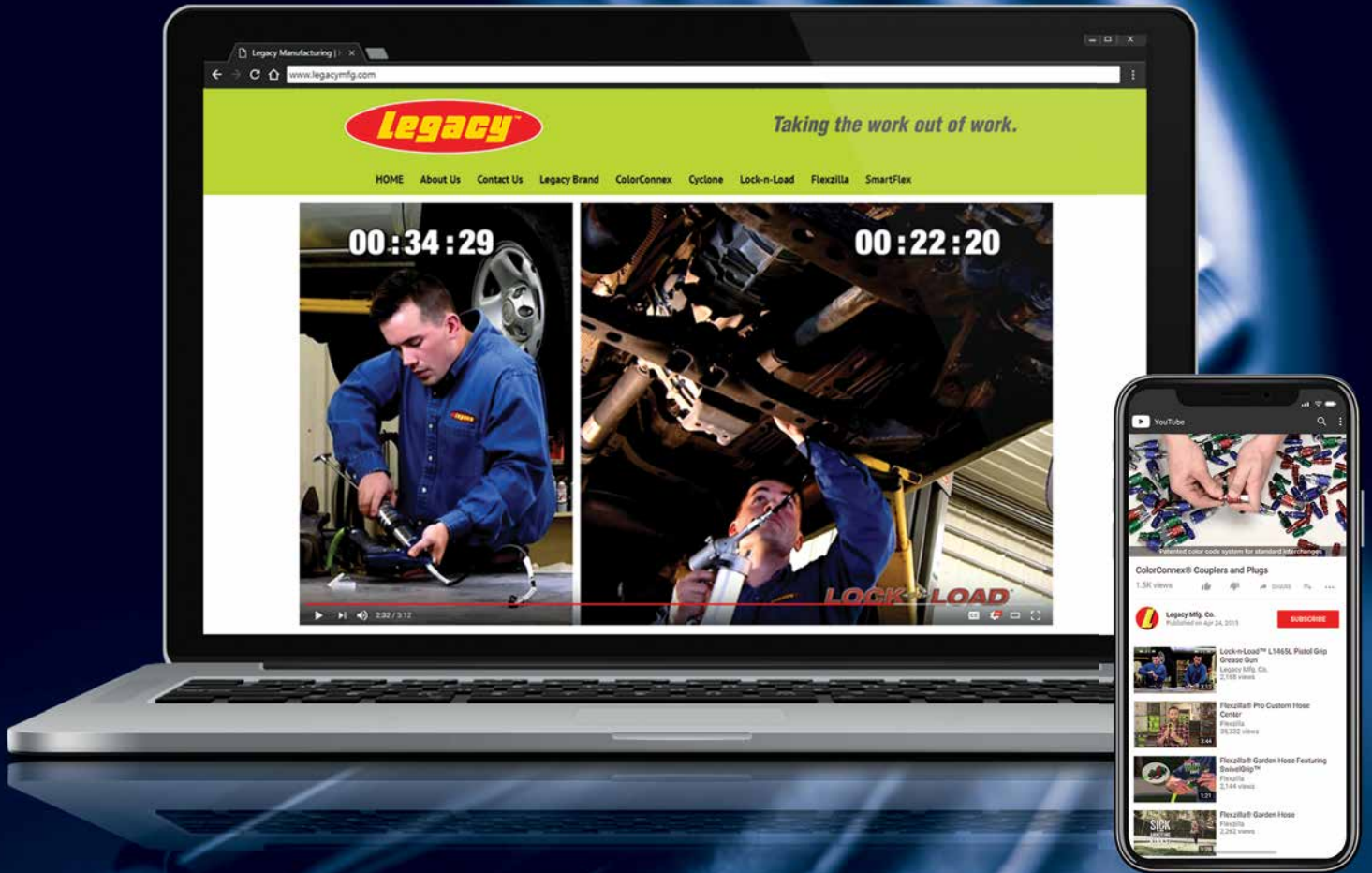

SEE LEGACY™ IN ACTION!

View our product videos online!

 legacymfg.com

 youtube.com/legacyinnovation

Videos available upon request



Legacy Manufacturing Company

6509 Partners Ave
Marion, IA 52302
phone: 319-373-7305
toll-free: 800-645-8258
email: info@legacymfg.com
legacymfg.com

For more information about Flexzilla products contact us at:

phone: 319-373-7305
toll-free: 800-645-8258
email: info@flexzilla.com
flexzilla.com

Visit Legacy... **See Flexzilla in Action!**



Published: May 1, 2018 Revision Date: November 1, 2019

Flexzilla is a registered trademark of Weems Industries, Inc.
Lock-n-Load: U.S. Pat. No. 8,297,476 - 7,337,927 - 7,377,406 and Canadian Registration No. 2,549,264
ColorConnex U.S. Pat. No. 7,980,599 & 8,430,431 and Canadian Registration No. 2,575,170

Copyright © 2019 Legacy Manufacturing Co. All Rights Reserved.