

INSTALLATION INSTRUCTIONS CARE AND MAINTENANCE

*American
Standard*

STAINLESS STEEL SINKS

Drop-In Sinks & Undercounter Mounting Sinks

Thank you for selecting American Standard - the benchmark of fine quality for over 100 years. To ensure this product is installed properly, please read these instructions carefully before you begin. (Certain installations may require professional help.) Also be sure your installation conforms to local codes.

⚠ CAUTION: PRODUCT IS FRAGILE. TO AVOID BREAKAGE AND POSSIBLE INJURY HANDLE WITH CARE!
NOTE: Pictures may not exactly define contour of china and components.

Before installing the sink, inspect it for damage. DO NOT install a damaged unit.
Notify your American Standard distributor of any damage. Replace sink its original packing.

OBSERVE LOCAL PLUMBING AND BUILDING CODES

Recommended Tools & Materials

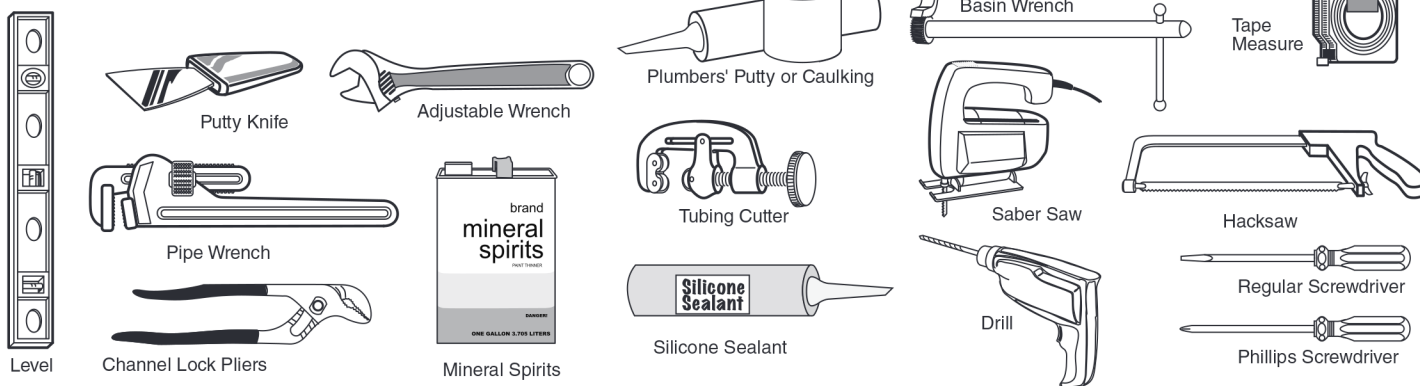

MAINTENANCE FOR STAINLESS STEEL SINKS:

To keep the original quality of your Stainless Steel Sink, we recommend regular cleaning. Use a mild liquid dish detergent and water to clean the product after use. Rinse carefully and dry.

PLEASE HAVE THE FOLLOWING IN MIND:

- Do not let water or other liquids dry on the product. Liquids that are left to dry leave a grey build-up stain on the steel.
- Stainless steel can stand hard treatment, but sharp objects can easily scratch the surface. These scratches are more visible when the product is new. After a period of use these marks will be smoothed out without the product losing its luster.
- Never use scouring powder or steel wool to clean the surface. Apart from the risk of scratches, there is also a risk that rust stains will attack the steel.
- Avoid Chlorine-based solutions from coming into contact with the stainless steel.
- Silver polish leaves spots that cannot be removed.
- Acidic foods (e.g. juices, salt, mustard, mayonnaise, etc.) must be cleaned up immediately.

DISCOLORATION

More stubborn spots are often caused by impurities in the water or household substances. These can be removed with special polish agents for stainless steel. Dull spots can become lustrous again if rubbed with chalk on a soft cloth.

SAVE FOR FUTURE USE

FOR DROP-IN SINK INSTALLATION

1 PREPARING THE COUNTERTOP

Make sure there are no obstructions such as cabinets, plumbing, etc. below or above the countertop.

Place template on countertop checking to make sure the sink will line up correctly with plumbing.

To begin the cutout for the sink, drill a hole then use a sabersaw to carefully cut along the template.

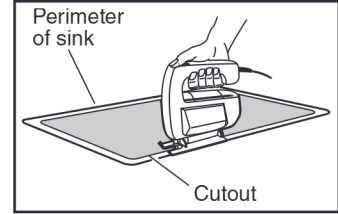
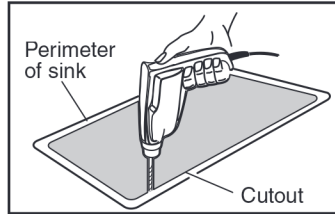

2 CHECK THE CUTOUT DIMENSIONS

Check the countertop cutout opening by placing the sink in the opening to be sure it is sized properly. The rim of the sink must be set uniformly on the countertop to ensure the corners of the sink seat properly. If the sink does not fit adjust the cutout opening using the saber saw.

3 PREPARING THE STRAINER AND FAUCET ASSEMBLY

NOTE: Your sink may not come with the strainer and faucet assembly in which case you will need to purchase separately and follow instructions included with the purchased products.

Install the strainer as shown.

Install the faucet following the instructions included with the faucet.

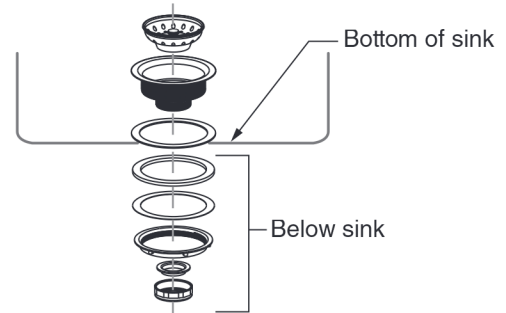

4 Apply a generous portion of sealant inside line traced on countertop.

5 Assemble the screw with the clamp as shown (1).

Slide the screw and clamp assembly under the open end of the U Channel as the location on the template suggests.

Turn the clamp in the same direction as the U Channel and hand tighten the screw as shown (2).

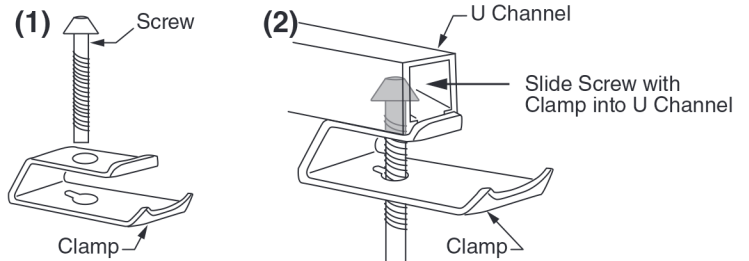

6 A. Carefully lower sink into cutout. Make sure the sink is in the proper location and press down firmly.

WARNING: Improper tightening of screws could result in improper installation or cause damage to the sink.

B. Loosen the screw and turn the clamp 90 degrees so the clamp can catch the bottom of countertop as shown. Hand tighten the screws.

C. Recheck sink position on countertop. Tighten all screws an additional 1/4 turn with a flat head screwdriver.

WARNING: DO NOT OVERTIGHTEN

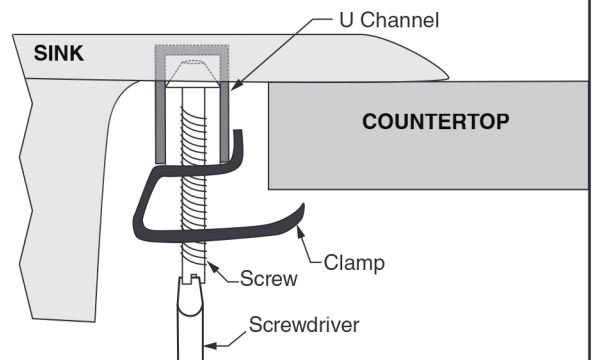

7 Connect supply lines to faucet finger tight, and carefully bend to engage with the supply stops. Tighten connections to faucet for secure seal.

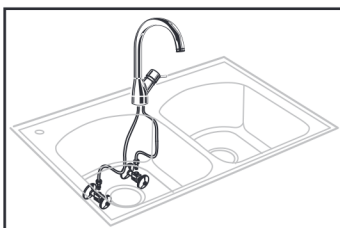

8 Connect drain assembly hand tight to check alignment. It may be necessary to cut off part of the tailpiece (area "A") or part of the horizontal leg of the trap (area "B"). Secure joint for watertight assembly.

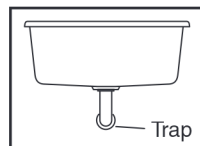

Single Bowl

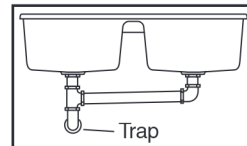

Double Bowl

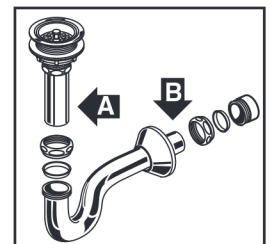

FOR UNDERCOUNTER MOUNTING SINK INSTALLATION

BEFORE YOU BEGIN...

Unpack new sink and inspect carefully for damage. Notify your American Standard distributor of any damage. Replace the sink in its original packing carton to protect it until you are ready to begin installation.

CAUTION

Strongly Recommend For Professional Installers to Perform Installation.

- Locate sink to be installed. Provide proper clearance under the countertop for the faucet supply lines and the structural parts of your cabinet. **NOTE:** Some templates share the drop-in and undercounter mounting. Make sure you used the undercounter mounting portion of the template.
- Cut the inner portion from the supplied template and discard.
- Attach the outer portion of the template to the countertop using masking tape. Be sure there is enough clearance for the faucet and supply line. If the template has a hole for the faucet, use 1-3/8" (35 mm) diameter hole saw to cut hole on the countertop.

- 1** Drill a clearance hole inside the cutout line.

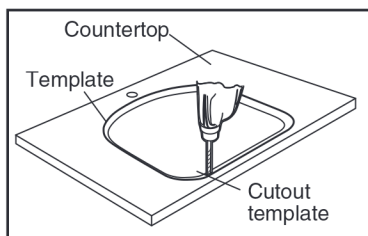

- 2** Cut opening on cut line of the template.

NOTE: Contact your countertop distributor for the best method of cutting materials such as marble, hard synthetics, etc.

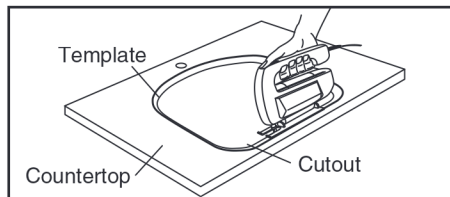

- 3** Fasteners for under counter mounting sink **ARE NOT** included. Anchor and clips should be supplied by your countertop supplier. Please consult your countertop supplier to install anchors into the the underside of countertop.

- 4** Apply sealant to the rim of the sink near the inside edge. Be careful not to miss or skip an area.



- 5**

Lift the sink into place. Follow the instructions from your countertop supplier in order to tighten the mounting hardware evenly.

⚠ DO NOT OVERTIGHTEN

- 6** Apply silicone sealant (optional). Wipe away any excess sealant. Fill voids and allow to cure.

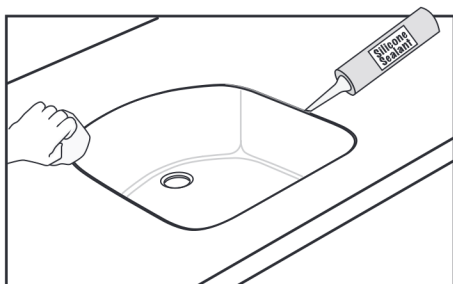

- 7**

Mount the faucet and strainer assembly following the manufacturer's instructions.

NOTE: Your sink may not come with the strainer and faucet assembly in which case you will need to purchase separately and follow instructions included with the purchased products.

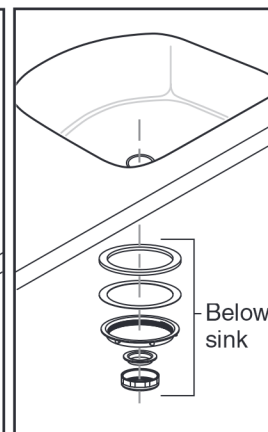
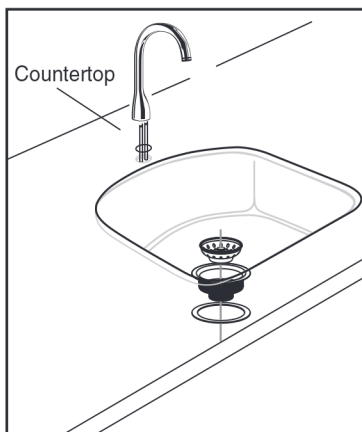

- 8** Connect supply lines to faucet finger tight, and carefully bend to engage with the supply stops. Tighten connections to faucet for secure seal.

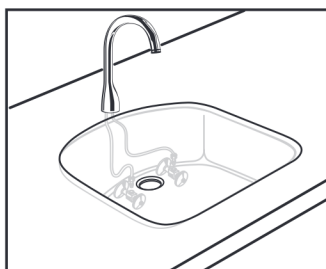

- 9**

Connect drain assembly hand tight to check alignment. It may be necessary to cut off part of the tailpiece (area "A") or part of the horizontal leg of the trap (area "B").

Secure joint for watertight assembly.

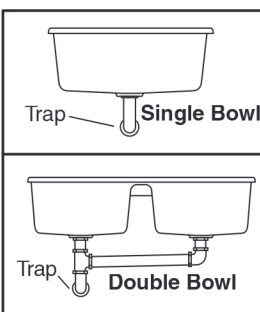
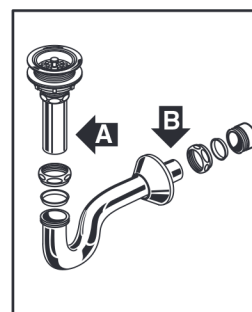

AS AMERICA, INC. LIMITED LIFETIME WARRANTY FOR STAINLESS STEEL SINKS

AS America, Inc. ("American Standard[®]") warrants to the original consumer purchaser of an American Standard stainless steel sink that it will, at its option, repair or replace such product if it is found by American Standard, in its sole judgment, to be defective under normal residential use, provided that it has been installed and maintained in accordance with American Standard's instructions. This limited warranty applies only to the initial installation and is not transferable from the original consumer purchaser. In the event of a limited warranty claim, proof of purchase will be required – **save sales receipt**.

This limited warranty does not apply to commercial installations. The warranty for commercial installations is three (3) years.

This limited lifetime warranty DOES NOT COVER the following:

Defects or damages arising from shipping, installation, alterations, accidents, abuse, misuse, environmental factors, lack of proper maintenance and use of other than genuine American Standard replacement parts, in all cases whether caused by a plumbing contractor, service company, the owner or any other person.

Deterioration through normal wear and tear and the expense of normal maintenance.

Commercial application.

Options and accessories. American Standard's limited warranty on these items is one year for parts only. This one year limited warranty covers accessories manufactured by American Standard against defects of material or workmanship. Limited warranty coverage begins on the date the accessory was originally purchased by the owner.

Postage or shipping costs for returning products for repairs or replacement under this limited warranty and labor or other costs incurred in connection with product removal or installation under this limited warranty.

ANY LIABILITY FOR CONSEQUENTIAL OR INCIDENTAL DAMAGES, INCLUDING LABOR, ALL OF WHICH ARE HEREBY EXPRESSLY DISCLAIMED, OR THE EXTENSION BEYOND THE DURATION OF THIS LIMITED WARRANTY OF ANY IMPLIED LIMITED WARRANTIES, INCLUDING THOSE OF MERCHANTABILITY OR FITNESS FOR AN INTENDED PURPOSE. IN NO EVENT WILL AMERICAN STANDARD BE LIABLE FOR THE COST OF REPAIR OR REPLACEMENT OF ANY INSTALLATION MATERIALS INCLUDING BUT NOT LIMITED TO TILES, MARBLE ETC. (Some jurisdictions do not allow limitations on how long an implied limited warranty lasts, or the exclusion or limitation of incidental or consequential damages, so these limitations and exclusions may not apply to you.)

Responsibility for compliance with local code requirements. (Since local code requirements vary greatly distributors, retailers, dealers, installation contractors and users of plumbing products should determine whether there are any code restrictions on the installation or use of a specific product.)

This limited warranty gives you specific legal rights. You may have other statutory rights that vary from state to state or from province to province, in which case this limited warranty does not affect such statutory rights.

In the United States:

American Standard Brands
P.O. Box 6820
Piscataway, New Jersey 08855
Attention: Director of Customer Care
For residents of the United States, warranty information may also be obtained by calling the following toll free number: (800) 442-1902
www.americanstandard.com

In Canada:

AS Canada, ULC
5900 Avebury Rd.
Mississauga, Ontario
Canada L5R 3M3
Toll Free: (800) 387-0369
www.americanstandard.ca

In Mexico:

American Standard B&K Mexico
S. de R.L. de C.V.
Via Morelos #330
Col. Santa Clara
Ecatepec 55540 Edo. Mexico
Toll Free: 01-800-839-1200
www.americanstandard.com.mx