



## RANGE HOODS



**4 TIME ENERGY STAR® PARTNER OF THE YEAR**  
2017, 2013 and 2012 Partner of the Year  
2014 Sustained Excellence & Climate Communications

[www.airkinglimited.com](http://www.airkinglimited.com)

# Table of Contents

Selecting Your Range Hood **Page 3**

---

## **PROFESSIONAL SERIES**

Advantage Professional Series Range Hoods **Page 4**

Create a Professional Range Hood **Page 5**

Professional Series Range Hoods **Page 6**

Professional Series Accessories **Page 7**

Professional Inserts **Page 8**

Professional Liners **Page 9**

---

## **POWER PACKS**

Power Packs **Page 10**

---

## **CHIMNEY RANGE HOODS**

Wall Mounted Range Hoods **Pages 11 - 12**

Island Mounted Range Hoods **Page 13**

---

## **ASHRAE 62.2 POWER PACKS / UNDER CABINET RANGE HOODS**

Under Cabinet Range Hoods **Pages 14 - 16**

---

## **UNDER CABINET RANGE HOODS**

Under Cabinet Range Hoods **Pages 17 - 23**

---

## **RANGE HOOD ACCESSORIES**

Range Hood Accessories **Pages 24 - 25**

---

## **RANGE HOOD SPECIFICATIONS**

Specifications **Pages 26 - 27**



# Selecting Your Range Hood

Air King offers a wide array of range hood solutions including ENERGY STAR® certified options. Selecting the perfect Air King range hood for your requirements can be done through the following considerations:

## ***Ducted Versus Ductless***

A ducted range hood takes the exhaust air and pushes it outside through either a wall or roof vent. A ductless range hood pushes the air through an internal grease and odor filter, then recirculates the air back into the room. Many hoods are listed as convertible meaning that they can be configured to operate ducted or ductless. To maximize the performance of your range hood it is recommended that it be ducted to the outside to ensure proper ventilation. Ducted range hoods are required for ENERGY STAR qualification as well as ASHRAE 62.2 requirements and provide the best solution. In situations where these requirements are not mandatory and ducting is not possible, a ductless range hood can be used.

## ***Determine How the Range Hood Will Mount***

There are 4 basic mounting styles - Wall, Island, Under Cabinet and Insert. A wall mounted range hood will as the name implies mount directly to the wall. These range hoods typically have a chimney or a soffit for the ducting and replace the cabinet over the range. An island mounted range hood will mount to the ceiling and will have a chimney for the ducting. An under cabinet mounted range hood will mount underneath the cabinet above your cooking surface. An insert is a power unit that inserts into a custom made canopy.

## ***Determine Your CFM***

CFM (Cubic Feet Per Minute) is the amount of air the range hood is exhausting. HVI (Home Ventilation Institute) recommends 1 CFM per 100 BTU's. So for instance a 10,000 BTU range would require a 100 CFM range hood.

## ***Choose The Sound Level (Sones)***

The next consideration is the sound level which is measured in Sones. The lower the sone, the quieter the range hood. A range hood with an operating speed around one sone is considered extremely quiet. When targeting a sound level, keep in mind that range hoods have multiple speeds. While the top speed will be higher in sound, for most cooking applications, the low speed or if present medium speed will be sufficient for your ventilation needs.

## ***Choose Your Features***

Features include night lights, heat bulbs, timers, and number of speeds or adjustable speeds to match the ventilation demands of the kitchen. Other items include styles such as chimney range hoods, professional style range hoods, traditional under cabinet hoods and so forth. Determine your style and if you will need any of these features for your application.

## ***Special Consideration***

Before selecting any range hood, you should consult all national and local codes such as ASHRAE 62.2 and California Title 24, to determine if any specialized requirements exist.



# Advantage Professional Series

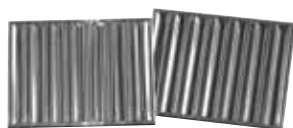

## FEATURES

- Three speed motor control (500 series include two speed motor control).
- High quality grade 430 stainless steel construction.
- Aluminum grease filters capture grease and debris from the cooking surface and are easily removed for cleaning. Professional grade, Stainless Steel, dishwasher safe baffles are available (AP1830BK for AP1830 models or AP1836BK for AP1836 models) and easily replace the aluminum filters included with the hood.
- **Included** dimmable 45 watt maximum Halogen lamps illuminate the cooking surface.
- **Included** vertical round outlet adapter, sized specific for the included motor (300 CFM: 6" round, 500 CFM: 8" round).
- **Suggested Accessories:** Back Splash, Soffit, Roof or Wall Cap (see pages 7, 24 for details).



Baffle filter kits available for 18" high models.



ADVANTAGE PROFESSIONAL SERIES							
	MODEL	HEIGHT/WIDTH/DEPTH	AIRFLOW (CFM)	SOUND (SONES)	DUCT SIZE	FINISH	LIGHTING
	AP1030-600	10" / 30" / 24"	600/500/300	5.5/4.5/1.5	8" round	Stainless Steel	3 - 45W Halogen
	AP1036-600	10" / 36" / 24"					
	AP1030-500	10" / 30" / 24"	500/300	4.5/1.5	6" round		
	AP1036-500	10" / 36" / 24"					
	AP1836-900	18" / 36" / 24"	900/600/400	11.0/5.5/2.0	8" round	Stainless Steel	3 - 45W Halogen
	AP1830-600	18" / 30" / 24"	600/500/300	5.5/4.5/1.5	8" round		
	AP1836-600	18" / 36" / 24"					
	AP1830-500	18" / 30" / 24"	500/300	4.5/1.5	6" round		
	AP1836-500	18" / 36" / 24"					



# Create a Professional Range Hood

## PROFESSIONAL RANGE HOODS

### Create Your Professional Range Hood

Put together the perfect Professional Range hood with this step by step guide to choosing the right individual components.



#### STEP 1 - Range Hood

Choose a Professional Range Hood, Professional Range Hood with Heat Lamp or a Professional Outdoor Range Hood Canopy to fit the size (height and width) of your installation.



#### STEP 2 - Blower

Choose a Professional Blower to meet the ventilation needs of your kitchen. The ventilation needs are typically dependent on the type and size of the cooking surface.

**NOTE:** When choosing a blower be sure to consult and adhere to any local and national codes regarding ventilation amounts and make-up air requirements.



#### STEP 3 - Soffit

For installations that will not have cabinets directly above the hood, choose a Professional Soffit to match the size (height and width) requirements of your installation.



#### STEP 4 - Duct Connections

Determine the size and type of ducting your installation requires and choose the appropriate Professional Outlet Adapter. To prevent drafts from entering back into the home choose a Professional Back Draft Damper according to your ducting size and finally make sure to choose a wall or roof cap to properly exhaust the air to the outside (see page 24 for available models).

**NOTE:** For maximum performance, the ducting size must match the requirements of the blower as described in the chart on page 7. All local and national codes must be adhered to concerning ducting and duct connections.



#### STEP 5 - Back Splash

Add a Professional Back Splash to protect your walls and put an elegant finishing touch to your installation. If a Professional Range Hood with Heat Lamp is installed, add a Professional Back Splash with shelves to maximize the effectiveness of the heat lamps.

Model P1036W with optional SFT3620 soffit



# Professional Series



## FEATURES

- Professional grade 304 stainless steel will not discolor over time.
- Professional Grade, Stainless Steel, dishwasher safe baffles capture grease and debris from the cooking surface and are easily removed using the integrated handle for cleaning. Model AP1836m features aluminum filters.
- **Included** dimmable 45 watt maximum Halogen lamps illuminate the cooking surface.
- Includes: Canopy, Grease Baffles/Filters, Controls, and Lamp Sockets.  
**Blower must be purchased separately** (see page 7 for options).
- **Suggested Accessories:** Back Splash, Soffit, Roof or Wall Cap (see pages 7, 24 for details).

**Models with Heat Lamps:** independently controlled dual 250 watt maximum heat lamps (heat lamps not included).

**Outdoor models:** Approved for use in covered outdoor kitchens.



**Don't forget to choose a blower (purchased separately) to power your unit:**

- B300 (300 CFM)
- B500 (500 CFM)
- B600 (600 CFM)
- B900 (900 CFM)
- B1125 (1200 CFM)



PROFESSIONAL SERIES							
	MODEL	HEIGHT/ WIDTH/DEPTH	AVAILABLE BLOWERS	HEAT LAMP	FINISH	APPROVED FOR OUTDOOR USE	LIGHTING
	P1030	10" / 30" / 24"	B300, B500, B600, B900, B1200	NO	Stainless Steel	NO	2 - 45W Halogen
	P1036	10" / 36" / 24"					
	P1036W	10" / 36" / 24"	B300, B500, B600, B900, B1200	2 - 250W	Stainless Steel	NO	2 - 45W Halogen
	P1836	18" / 36" / 24"	B300, B500, B600, B900, B1200	NO	Stainless Steel	NO	2 - 45W Halogen
	P1842	18" / 42" / 24"					3 - 45W Halogen
	P1848	18" / 48" / 24"					3 - 45W Halogen
	P1836W	18" / 36" / 24"	B300, B500, B600, B900, B1200	2 - 250W	Stainless Steel	NO	2 - 45W Halogen
	P1842W	18" / 42" / 24"					3 - 45W Halogen
	P1848W	18" / 48" / 24"					3 - 45W Halogen
	P1836m	18" / 36" / 24"	B600, B900, B1200	NO	Stainless Steel	YES	3 - 45W Halogen
	P1842m	18" / 42" / 24"					
	P1848m	18" / 48" / 24"					
	AP1836m	18" / 36" / 24"	B600, B900, B1200	NO	Stainless Steel	YES	3 - 45W Halogen

# Professional Series Accessories

## PROFESSIONAL RANGE HOOD BLOWERS

Bring life to your Professional Range Hood System with the power and precision of the Professional Blower Series.

Each Professional Blower is designed and engineered to the highest standards ensuring long life and dependability while providing powerful ventilation. Air King allows the freedom to choose a blower specific to your ventilation needs with multiple options that universally fit with all Air King Professional Series products.



- **For use with:** Professional Range Hood Canopies  
Professional Outdoor Range Hood Canopies  
Professional Inserts
- Snap-In wiring harness connector makes electrical connection and installation into canopy quick and simple.
- Permanently lubricated ball bearing motor with an electronically balanced blower wheel provides long lasting and dependable ventilation for years.
- Hood Canopy is purchased separately (see pages 9 and 10 for models).

\* Blowers are designed for use with Air King Professional Series hoods and inserts only.

MODEL	HVI CFM/SONES @ 0.1 WG			MINIMUM DUCT SIZE
	HIGH	MEDIUM	LOW	
B300	300/1.5	N/A <sup>2</sup>	N/A <sup>2</sup>	6" round
B500	500/4.5	N/A <sup>3</sup>	300/1.5 <sup>3</sup>	6" round
B600	600/5.5	500/4.5	300/1.5	8" round
B900	900/11.0	600/5.5	400/2.0	8" round
B1125	1200/15.0	900/11.0	400/2.0	10" round



<sup>2</sup> All speed selections operate at same speed  
<sup>3</sup> Speed selections II and III operate at same speed  
CFM = cubic feet per minute • Sones = sound level measurement  
HVI Certified at 0.1 Static Pressure

## PROFESSIONAL RANGE HOOD SOFFITS

Enhance the elegance of your hood with the finishing touch of a Professional Range Hood Soffit. Professional Range Hood Soffits are available in 12" or 20" heights, in multiple widths to fit perfectly with your Professional Range Hood or Professional Range Hood with Heat Lamp. The Soffits are able to be combined to accommodate higher ceilings and are crafted from the same Stainless Steel as the hoods to ensure an exact match of the finishes.



MODEL	WIDTH	HEIGHT	DEPTH
SFT3012	30"	12"	12"
SFT3612	36"	12"	12"
SFT4212	42"	12"	12"
SFT4812	48"	12"	12"

MODEL	WIDTH	HEIGHT	DEPTH
SFT3020	30"	20"	12"
SFT3620	36"	20"	12"
SFT4220	42"	20"	12"
SFT4820	48"	20"	12"

## PROFESSIONAL RANGE HOOD BACK SPLASHES

Add the finishing touch to complete the elegance of your hood with a Stainless Steel Professional Back Splash. To complement the Professional Range Hood with Heat Lamp Series add a Back Splash that includes built-in shelves to maximize the effectiveness of the heat lamps.

MODEL	WIDTH	HEIGHT	SHELVES
BS30	30"	33½"	NO
BS36	36"	33½"	NO
BS42	42"	33½"	NO
BS48	48"	33½"	NO
BS36W	36"	33½"	YES
BS42W	42"	33½"	YES
BS48W	48"	33½"	YES



## PROFESSIONAL RANGE HOOD OUTLET ADAPTERS

Properly connect your ducting to your Professional Series range hood using the correct outlet adapter.

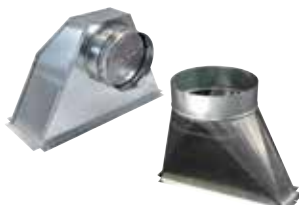

MODEL	DUCT SIZE	MOTOR SIZE	DIRECTION
OA6VD	6" round	300/500	Vertical
OA8VD	8" round	600/900	Vertical
OA10VD	10" round	1200	Vertical
OA6HD	6" round	300/500	Horizontal
OA8HD	8" round	600/900	Horizontal
OA10HD	10" round	1200	Horizontal

# Professional Inserts



## FEATURES

- Approved for indoor use as well as for covered outdoor kitchens.
- Professional Grade, Stainless Steel, dishwasher safe baffles capture grease and debris from the cooking surface and are easily removed using the integrated handle for cleaning.
- **Included** dimmable 45 watt maximum Halogen lamps illuminate the cooking surface.
- Quad inlet twin blower provides powerful ventilation with quiet operating speeds.
- Stainless steel fascia (stainless steel insert liners available separately).
- **Suggested Accessories:** HL Series Liner, Back Splash, Roof or Wall Cap (see pages 7, 24 for details).



## PROFESSIONAL INSERTS

	MODEL	FITS CABINETS	CUTOUT OPENING	AIRFLOW (CFM)	SOUND (SONES)	DUCT SIZE	FACIA FINISH	LIGHTING
	PIN28m-300	30" or larger	26 $\frac{3}{4}$ "W x 15 $\frac{1}{4}$ "D	300/200/140	4.5/2.0/0.7	6" round	Stainless Steel	2 - 45W Halogen
	PIN300m	36" or larger	30"W x 17"D					
	PIN28m-400	30" or larger	26 $\frac{3}{4}$ "W x 15 $\frac{1}{4}$ "D	400/300/200	8.0/6.0/2.0			
	PIN400m	36" or larger	30"W x 17"D					
	PIN28m-600	30" or larger	26 $\frac{3}{4}$ "W x 15 $\frac{1}{4}$ "D	600/500/300	5.5/4.5/1.5	8" round	Stainless Steel	2 - 45W Halogen
	PIN600m	36" or larger	30"W x 17"D					
	PIN28m-900	30" or larger	26 $\frac{3}{4}$ "W x 15 $\frac{1}{4}$ "D	900/600/400	11.0/5.5/2.0			
	PIN900m	36" or larger	30"W x 17"D					
PIN28m-1200	30" or larger	26 $\frac{3}{4}$ "W x 15 $\frac{1}{4}$ "D	1200/900/400	15.0/11.0/2.0	10" round	Stainless Steel	2 - 45W Halogen	
PIN1200m	36" or larger	30"W x 17"D						

## OPTIONAL HOOD INSERT LINERS

	MODEL	FITS CABINETS	WIDTH	DEPTH	HEIGHT	FINISH
	HL30PIN	30" wide	28 $\frac{1}{2}$ "	24"	4"	Stainless Steel
	HL36PIN	36" wide	34 $\frac{1}{2}$ "			
	HL42PIN	42" wide	40 $\frac{1}{2}$ "			
	HL48PIN	48" wide	46 $\frac{1}{2}$ "			
	HL54PIN	54" wide	52 $\frac{1}{2}$ "			
	HL60PIN	60" wide	58 $\frac{1}{2}$ "			

## DIMENSIONS

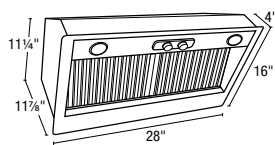

PIN28 Series

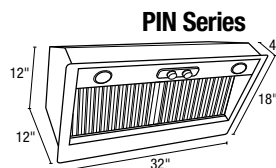

PIN Series

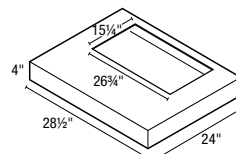

HL30PIN

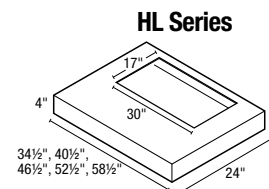

HL Series

34 $\frac{1}{2}$ ", 40 $\frac{1}{2}$ ", 46 $\frac{1}{2}$ ", 52 $\frac{1}{2}$ ", 58 $\frac{1}{2}$ "



# Professional Liners



## FEATURES

- Approved for indoor use as well as for covered outdoor kitchens.
- Professional Grade, Stainless Steel, dishwasher safe baffles capture grease and debris from the cooking surface and are easily removed using the integrated handle for cleaning.
- **Included** dimmable 45 watt maximum Halogen lamps illuminate the cooking surface.
- Quad inlet twin blower with three speed motor control provides powerful ventilation with quiet operation.
- **Included**, vertical round outlet adapter, sized specific for the included motor (400 CFM: 6" round, 600 CFM: 8" round, 1200 CFM: 10" round).
- Stainless steel fascia with integrated liner.
- **Suggested Accessories:** Back Splash, Roof or Wall Cap (see pages 7, 24 for details).



## PROFESSIONAL LINERS

MODEL	FITS CABINETS	CUTOUT OPENING	AIRFLOW (CFM)	SOUND (SONES)	OUTDOOR USE*	DUCT SIZE	FACIA FINISH	LIGHTING
LIN28m-400	30"W x 20¾"D	28¾"W x 19¼"D	400/300/200	8.0/6.0/2.0	NO	6" round	Stainless Steel	2 - 45W Halogen
LIN28md-400	30"W x 24"D	28¾"W x 22½"D						
LIN28m-600	30"W x 20¾"D	28¾"W x 19¼"D	600/500/300	5.5/4.5/1.5	YES	8" round		
LIN28md-600	30"W x 24"D	28¾"W x 22½"D						
LIN34m-400	30"W x 20¾"D	34¾"W x 19¼"D	400/300/200	8.0/6.0/2.0	NO	6" round		
LIN34md-400	30"W x 24"D	34¾"W x 22½"D						
LIN34m-600	36"W x 20¾"D	34¾"W x 19¼"D	600/500/300	5.5/4.5/1.5	YES	8" round		
LIN34md-600	36"W x 24"D	34¾"W x 22½"D						
LIN40m-400	42"W x 20¾"D	40¾"W x 19¼"D	400/300/200	8.0/6.0/2.0	NO	6" round		
LIN40md-400	42"W x 24"D	40¾"W x 22½"D						
LIN40m-600	42"W x 20¾"D	40¾"W x 19¼"D	600/500/300	5.5/4.5/1.5	YES	8" round		
LIN40md-600	42"W x 24"D	40¾"W x 22½"D						
LIN46md-1200	48"W x 24"D	46¾"W x 22½"D	1200/900/400	15.0/11.0/2.0	YES	10" round	Stainless Steel	2 - 45W Halogen
LIN58md-1200	60"W x 24"D	58¾"W x 22½"D	1200/900/400	15.0/11.0/2.0	YES	10" round	Stainless Steel	4 - 45W Halogen



### DIMENSIONS

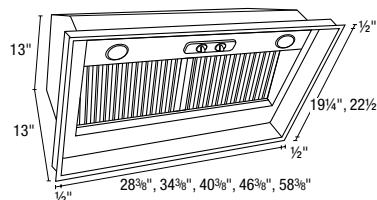

# Power Packs

## FEATURES

- Aluminum grease filters capture grease and debris from the cooking surface and are easily removed for cleaning.
- ESSEV / LE Series: Included** dual 6.5 watt GU10 base LED lamps, **Complies with California Title 24 requirements.**  
*L / SEV Series: Included* dual 50 watt Halogen lights with On/Off control are positioned for total cook top surface coverage.
- Stainless Steel fascia with Stainless Steel Hood Insert Liners (available separately) to give the inside of a custom built canopy a finished look.
- 6" round duct adapter with back draft damper included (LE600 and L600 include 10" round duct adapter).
- Suggested Accessories:** Back Splash, Hood Liner, Roof or Wall Cap.



## POWER PACKS

	MODEL	FITS CABINETS	CUTOUT OPENING	AIRFLOW (CFM)	SOUND (SONES)	DUCT SIZE	FACIA FINISH	LIGHTING	ENERGY STAR® CERTIFIED
	ESSEV28	30" or larger	27"W x 10"D	300/200/140	4.5/2.5/1.2	6" round	Stainless Steel	2 - 500 Lumens, 6.5W LED, 3000K	YES
	LE300	30" or larger	27"W x 10"D	300/200/150	4.5/2.0/0.7	6" round	Stainless Steel	2 - 500 Lumens, 6.5W LED, 3000K	YES
	L300	30" or larger	27"W x 10"D	300/200/150	4.5/2.0/0.7	6" round	Stainless Steel	2 - 50W Halogen	NO
	LE600	30" or larger	27"W x 10"D	600/400/200	4.0/2.5/0.3	10" round	Stainless Steel	2 - 500 Lumens, 6.5W LED, 3000K	YES
	L600	30" or larger	27"W x 10"D	600/400/200	4.0/2.5/0.3	10" round	Stainless Steel	2 - 50W Halogen	NO
	SEV24AB	24" or larger	18"W x 10"D	300	4.5	6" round	Stainless Steel	2 - 50W Halogen	NO
	SEV24S	24" or larger	18"W x 10"D	450	11.5				
	SEV28AB	30" or larger	27"W x 10"D	300	4.5				
	SEV28S	30" or larger	27"W x 10"D	500	11.5				

## OPTIONAL HOOD INSERT LINERS

	MODEL	FITS CABINETS	CUTOUT OPENING	WIDTH	DEPTH	HEIGHT	FINISH	USE WITH
	HL24RS	24" wide	18"W x 10"D	22½"	21"	3½"	Stainless Steel	SEV24AB, SEV24S
	HL28RS	30" wide	27"W x 10"D	28½"	21"	3½"	Stainless Steel	ESSEV28, LE300, L300, LE600, L600, SEV28AB, SEV28S
	HL36RS	36" wide	27"W x 10"D	34½"	21"	3½"	Stainless Steel	ESSEV28, LE300, L300, LE600, L600, SEV28AB, SEV28S

## DIMENSIONS

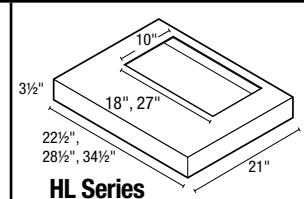
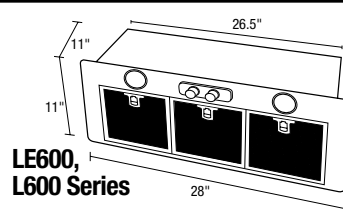
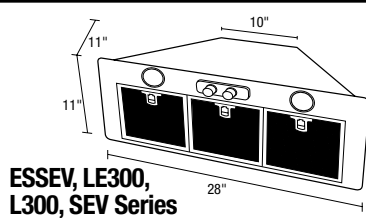
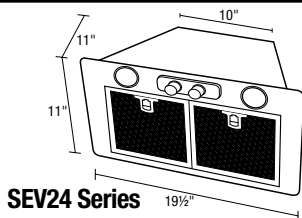

# Wall Mounted Range Hoods

## FEATURES:

- Three speed motor control.
- Aluminum grease filters capture grease and debris from the cooking surface and are easily removed for cleaning.
- **ESVAL SERIES: Included** dual 6.5 watt GU10 base LED lamps, **Complies with California Title 24 requirements.**

**VAL SERIES: Included** dual 50 watt Halogen lights with On/Off control are positioned for total cook top surface coverage.

- Convertible ducting - Vertical or Ductless<sup>1</sup>.

The ENERGY STAR Program for Residential Ventilating Fans has no provision for qualification of ductless range hoods (recirculating not ventilating), as a result the ENERGY STAR program applies to ducted range hoods only.

- Chimney extensions available for higher ceilings sold separately (VALWSE - White, VALBSE - Black, VALSSE - Stainless Steel).
- **Suggested Accessories:** Back Splash, WSV30 (30") or WSV36 (36") Spice Shelf, Roof or Wall Cap.





## OPTIONAL SPICE SHELF

Model WSV30 for ESVAL30, VAL30

Model WSV36 for ESVAL35, VAL36



## WALL MOUNTED RANGE HOODS

	MODEL	WIDTH	AIRFLOW (CFM)	SOUND (SONES)	DUCT SIZE	FINISH	LIGHTING	ENERGY STAR® CERTIFIED	
	ESVAL30SS	30"	300/170	4.5/1.3	6" round	Stainless Steel	2 - 6.5W LED	YES	
	ESVAL36SS	36"							
	VAL30SSAB	30"	300	4.5		6" round	Stainless Steel	2 - 50W Halogen	NO
	VAL30SS	30"	500	11.0					
	VAL36SSAB	36"	300	4.5					
	VAL36SS	36"	500	11.0					
	ESVAL30WH	30"	300/170	4.5/1.3	6" round	White	2 - 6.5W LED	YES	
	ESVAL36WH	36"							
	VAL30WHAB	30"	300	4.5		6" round	White	2 - 50W Halogen	NO
	VAL30WH	30"	500	11.0					
	VAL36WHAB	36"	300	4.5					
	VAL36WH	36"	500	11.0					
	ESVAL30BL	30"	300/170	4.5/1.3	6" round	Black	2 - 6.5W LED	YES	
	ESVAL36BL	36"							
	VAL30BLAB	30"	300	4.5		6" round	Black	2 - 50W Halogen	NO
	VAL30BL	30"	500	11.0					
	VAL36BLAB	36"	300	4.5					
	VAL36BL	36"	500	11.0					

## DIMENSIONS

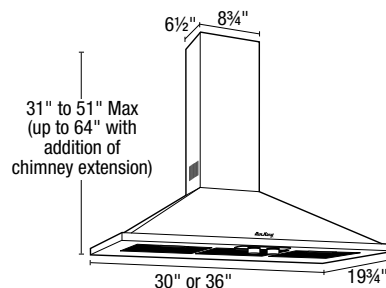

# Wall Mounted Range Hoods



## FEATURES

- Electronic blower delay timer automatically shuts the unit off after 20 minutes, when selected.
- Aluminum grease filters capture grease and debris from the cooking surface and are easily removed for cleaning.
- **Includes** Two 50 watt halogen lights with On/Off control are positioned for total cook top surface coverage.
- Convertible ducting - Vertical or Ductless<sup>1</sup>.
- Stainless Steel Chimney extensions available for higher ceilings, sold separately (model ARASE for ARA36GL, model GRASE for GRAN30 and GRAN36, model GRANSSE48 for GRAN48).
- **Suggested Accessories:** Back Splash, Roof or Wall Cap, WSV30 (30") or WSV36 (36") Spice Shelf for GRAN series.



**SEGOVIA SERIES (SEG36SS):** Powerful 4 speed motor that provides up to 600 CFM of ventilation.

**ARAGON™ GLASS SERIES (ARA36GL):** Powerful 3 speed motor that provides up to 570 CFM of ventilation.

**GRANADA SERIES (GRAN30SS, GRAN36SS, GRAN48SS):** Powerful 4 speed motor that provides up to 600 CFM of ventilation.



## WALL MOUNTED RANGE HOODS

	MODEL	WIDTH	AIRFLOW (CFM)	SOUND (SONES)	DUCT SIZE	FINISH	LIGHTING	DELAY TIMER
	SEG36SS	36"	600	14.0	6" round	Stainless Steel	2 - 50W Halogen	20 minutes
	ARA36GL	36"	570	12.5	6" round	Stainless Steel/ Glass	2 - 50W Halogen	20 minutes
	GRAN30SS	30"	600	14.0	6" round	Stainless Steel	2 - 50W Halogen	20 minutes
	GRAN36SS	36"						
	GRAN48SS	48"						

## DIMENSIONS

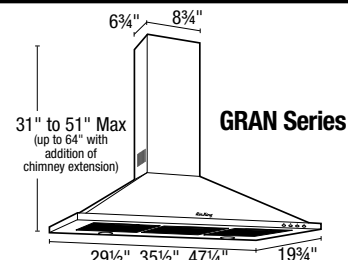
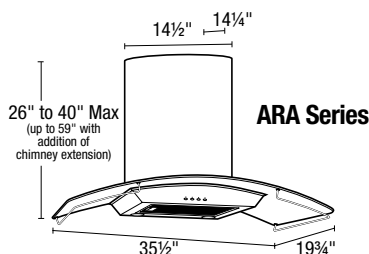
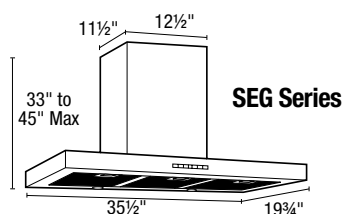



# Island Mounted Range Hoods

## FEATURES

- **Includes** 50 watt halogen lights with On/Off control are positioned for total cook top surface coverage. ALI Series - Includes, 2 fully enclosed 40 watt cook top lights.
- Aluminum grease filters capture grease and debris from the cooking surface and are easily removed for cleaning.
- Convertible ducting - Vertical or Ductless<sup>1</sup>.
- Chimney extensions available for higher ceilings sold separately (IBISEXT, MALSE, ALIWHEXT - White, ALIBLEXT - Black, ALISSEXT - Stainless Steel).
- **Suggested Accessories:** Back Splash, Roof or Wall Cap.





**IBIZA™ SERIES (IBIZ36GL):** Powerful 3 speed motor that provides up to 570 CFM of ventilation.

**PAMPLONA SERIES (PAMP36SS):** Powerful 4 speed motor that provides up to 600 CFM of ventilation.

**MALLORCA™ SERIES (MAL36SS):** Powerful 3 speed motor that provides up to 600 CFM of ventilation.

**ALICANTE™ SERIES (ALI36SS, ALI36WH, ALIBL):** Powerful 3 speed motor that provides up to 500 CFM of ventilation.

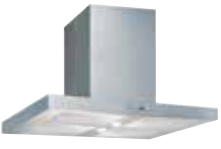

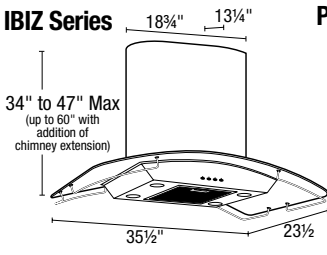
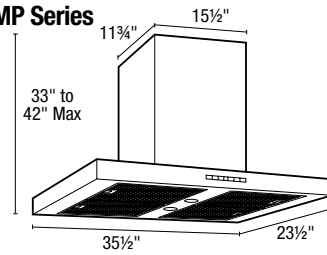
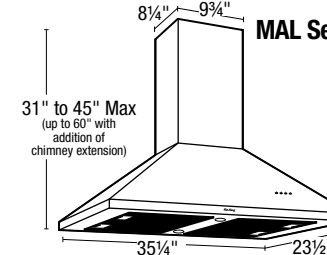
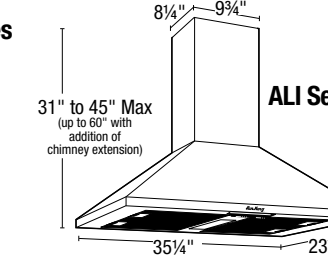
ISLAND MOUNTED RANGE HOODS								
	MODEL	WIDTH	AIRFLOW (CFM)	SOUND (SONES)	DUCT SIZE	FINISH	LIGHTING	DELAY TIMER
	IBIZ36GL	36"	570	12.5	6" round	Stainless Steel/ Glass	4 - 50W Halogen	20 minutes
	PAMP36SS	36"	600	14.0	6" round	Stainless Steel	2 - 50W Halogen	20 minutes
	MAL36SS	36"	600	14.0	6" round	Stainless Steel	2 - 50W Halogen	20 minutes
	ALI36SS	36"	500	11.0	6" round	Stainless Steel	2 - 40W Incandescent	-
	ALI36WH	36"	500	11.0	6" round	White	2 - 40W Incandescent	-
	ALI36BL	36"	500	11.0	6" round	Black	2 - 40W Incandescent	-
DIMENSIONS								
<b>IBIZ Series</b>  <p>18 3/4" x 13 1/4" top panel 34" to 47" Max (up to 60" with addition of chimney extension) 35 1/2" x 23 1/2" base</p>	<b>PAMP Series</b>  <p>11 3/4" x 15 1/2" top panel 33" to 42" Max 35 1/2" x 23 1/2" base</p>	<b>MAL Series</b>  <p>8 1/4" x 9 3/4" top panel 31" to 45" Max (up to 60" with addition of chimney extension) 35 1/4" x 23 1/2" base</p>	<b>ALI Series</b>  <p>8 1/4" x 9 3/4" top panel 31" to 45" Max (up to 60" with addition of chimney extension) 35 1/4" x 23 1/2" base</p>					

# Continuous Ventilation Range Hoods



## ASHRAE 62.2 Kitchen Ventilation Solutions



- **Two with One:** Solve for kitchen ventilation AND ASHRAE 62.2 continuous ventilation with one range hood instead of multiple fans.
- **Limit the Particulates:** The kitchen is typically the largest contributor to particulates, especially fine particulates. Using the range hood to solve for continuous ventilation places the ventilation at the most effective location to ventilate these particulates.
- **Location:** The kitchen is generally located in a central part of the home, so it only makes sense to locate the continuous ventilation there.

## FEATURES

- **Quiet, energy efficient operation.**
- Solutions for ASHRAE 62.2 continuous whole house ventilation without needing to install additional exhaust fans.
- **Adjustable Capacity Motor:** 4 capacity settings on low speed allow the fan to be set to the required exhaust rate for continuous ventilation. Low speed set points include: 30, 50, 70, or 90 CFM with a sound level of **<0.3 Sones**. High speed clears the air of moisture, odors or other contaminants directly above one of the main sources of indoor air contaminates.
- **Included** dual 6.5 watt GU10 base LED lamps, **Complies with California Title 24 requirements.**
- Aluminum grease filters capture grease and debris from the cooking surface and are easily removed for cleaning.
- Stainless Steel fascia with Stainless Steel Hood Insert Liners (available separately - see page 10) to give the inside of a custom built canopy a finished look.
- **LE300A:** 6" round duct adapter with back draft damper included.  
**LE600A:** 10" round all metal model OA10V outlet adapter included.
- **Suggested Accessories:** Back Splash, Hood Liner, Roof or Wall Cap.



### POWER PACKS

	MODEL	FITS CABINETS	CUTOUT OPENING	AIRFLOW (CFM)	SOUND (SONES)	DUCT SIZE	FACIA FINISH	LIGHTING	ENERGY STAR® CERTIFIED
	LE300A	30" or larger	26.875"W x 10"D	300/200/140	4.5/2.5/0.7	6" round	Stainless Steel	2 - 500 Lumens, 6.5W LED, 3000K	YES
	LE600A	30" or larger	26.875"W x 10"D	600/400/200	4.0/2.5/0.3	10" round	Stainless Steel	2 - 500 Lumens, 6.5W LED, 3000K	YES

### DIMENSIONS

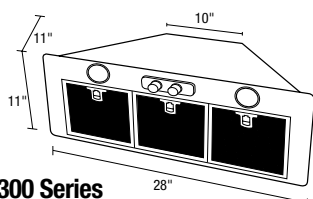

LE300A, LE300 Series

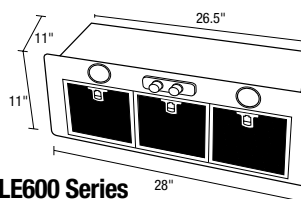

LE600A, LE600 Series

# Continuous Ventilation Range Hoods



## ASHRAE 62.2 Kitchen Ventilation Solutions

- **Two with One:** Solve for kitchen ventilation AND ASHRAE 62.2 continuous ventilation with one range hood instead of multiple fans.
- **Limit the Particulates:** The kitchen is typically the largest contributor to particulates, especially fine particulates. Using the range hood to solve for continuous ventilation places the ventilation at the most effective location to ventilate these particulates.
- **Location:** The kitchen is generally located in a central part of the home, so it only makes sense to locate the continuous ventilation there.

## FEATURES

- **Quiet, energy efficient operation.**
- Solutions for ASHRAE 62.2 continuous whole house ventilation without needing to install additional exhaust fans.
- **Adjustable Capacity Motor:** 4 capacity settings on low speed allow the fan to be set to the required exhaust rate for continuous ventilation. Low speed set points include: 30, 50, 70, or 90 CFM with a sound level of **<0.3 Sones**. High speed clears the air of moisture, odors or other contaminants directly above one of the main sources of indoor air contaminants.
- **Included** dual 6.5 watt GU10 base LED lamps, **Complies with California Title 24 requirements.**
- Constructed of high quality grade 430 stainless steel.
- Can be ducted either horizontally or vertically with the included 3¼" x 10" duct collar (ducting available separately).
- **Suggested Accessories:** Back Splash, Roof or Wall Cap.

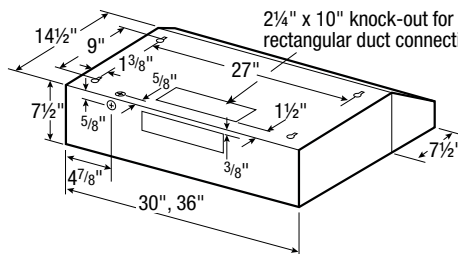

ECV SERIES RANGE HOODS								ENERGY STAR® CERTIFIED
	MODEL	WIDTH	AIRFLOW (CFM)	SOUND (SONES)	FINISH	LIGHTING	DUCTING OPTIONS	
	ECV308	30"	Horizontal 250 / 150	Horizontal 3.5 / 0.6	Stainless Steel	2 - 500 Lumens, 6.5W LED, 3000K	3¼" x 10"	YES
	ECV368	36"	Vertical 250 / 150	Vertical 4.0 / 0.6				
<b>DIMENSIONS</b>								
 <p>2¼" x 10" knock-out for 3¼" x 10" rectangular duct connection</p>								

# Continuous Ventilation Range Hoods



## ASHRAE 62.2 Kitchen Ventilation Solutions



- **Two with One:** Solve for kitchen ventilation AND ASHRAE 62.2 continuous ventilation with one range hood instead of multiple fans.
- **Limit the Particulates:** The kitchen is typically the largest contributor to particulates, especially fine particulates. Using the range hood to solve for continuous ventilation places the ventilation at the most effective location to ventilate these particulates.
- **Location:** The kitchen is generally located in a central part of the home, so it only makes sense to locate the continuous ventilation there.

## FEATURES

- **Quiet, energy efficient operation**
- Solutions for ASHRAE 62.2 continuous whole house ventilation without needing to install additional exhaust fans.
- **Adjustable Capacity Motor:** 4 capacity settings on low speed allow the fan to be set to the required exhaust rate for continuous ventilation. Low speed set points include: 30, 50, 70, or 90 CFM with a sound level of **<0.3 Sones**. High speed clears the air of moisture, odors or other contaminants directly above one of the main sources of indoor air contaminants.
- **Included 8 watt GU24 base LED lamp, Complies with California Title 24 requirements.**
- Available in stainless steel, white or black.
- Can be ducted either horizontally or vertically with the included 3/4" x 10" duct collar (ducting available separately).
- **Suggested Accessories:** Back Splash, Roof or Wall Cap.



### ECQ SERIES RANGE HOODS

	MODEL	WIDTH	AIRFLOW (CFM)	SOUND (SONES)	FINISH	LIGHTING	DUCTING OPTIONS	ENERGY STAR® CERTIFIED		
	ECQ248	24"	Horizontal 250 / 150	Horizontal 3.5 / 0.6	Stainless Steel	675 Lumens, 8W LED, 4000K	3/4" x 10"	YES		
	ECQ308	30"								
	ECQ368	36"								
	ECQ243	24"			Vertical 250 / 150	Vertical 4.0 / 0.6	White	675 Lumens, 8W LED, 4000K	3/4" x 10"	YES
	ECQ303	30"								
	ECQ363	36"								
	ECQ246	24"					Black	675 Lumens, 8W LED, 4000K	3/4" x 10"	YES
	ECQ306	30"								
	ECQ366	36"								

### DIMENSIONS

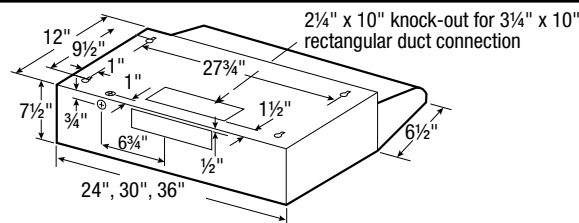



# Under Cabinet Range Hoods



## FEATURES



- Two speed motor control.
- Contemporary shape fits all decors while the solid underside allows for easy cleaning.
- Included, easily removable aluminum grease filters capture grease and debris.
- **Included** dual 6.5 watt GU10 base LED lamps, **Complies with California Title 24 requirements.**
- Constructed of high quality grade 430 stainless steel.
- Can be ducted either horizontally or vertically with the included 3/4" x 10" duct collar and back draft damper (ducting available separately).
- **Suggested Accessories:** Back Splash, Roof or Wall Cap.

## AMERICANS WITH DISABILITIES ACT (ADA) Compliant models

- Included dual rocker, white control switch mounts to the wall at an accessible height. Fits a triple gang box.



## DELUXE QUIET ADVANTAGE SERIES

	MODEL	WIDTH	AIRFLOW (CFM)	SOUND (SONES)	FINISH	LIGHTING	DUCTING OPTIONS	ADA COMPLIANT	ENERGY STAR® CERTIFIED
	ESAPDQ30	30"	High 270	High 4.0	Stainless Steel	2 - 500 Lumens, 6.5W LED, 3000K	3/4" x 10"	NO	YES
	ESAPDQ36	36"							
	ESAP30ADA	30"	Low 150	Low 1.5				YES	
	ESAP36ADA	36"							

### DIMENSIONS

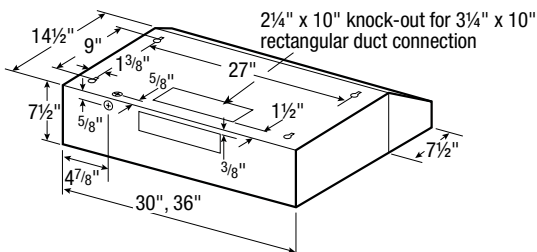

# Under Cabinet Range Hoods









## FEATURES

- Two speed motor control.
- Included, easily removable aluminum grease filters capture grease and debris.
- **EB Series: Included** dual 6.5 watt GU10 base LED lamps, **Complies with California Title 24 requirements.**  
**AB Series: Included** dual halogen lights with 2 brightness settings and positioned for total cook top surface coverage.
- Ducting options: Horizontally or vertically with the included duct collar and back draft damper for 3¼" x 10"  
7" round with the included duct collar and back draft damper.  
Ductless with the addition of charcoal odor filters (30" models CF-09, 36" models CF-10, available separately).  
The ENERGY STAR Program for Residential Ventilating Fans has no provision for qualification of ductless range hoods (recirculating not ventilating), as a result the ENERGY STAR program applies to ducted range hoods only.
- **Suggested Accessories:** Back Splash, Roof or Wall Cap.



## ESSENCE SERIES RANGE HOODS

	MODEL	WIDTH	AIRFLOW (CFM)	SOUND (SONES)	FINISH	LIGHTING	DUCTING OPTIONS	ENERGY STAR® CERTIFIED
	EB30SS	30"	Horizontal 250 / 100	Horizontal 5.0 / 0.9	Stainless Steel	2 - 500 Lumens, 6.5W LED, 3000K	¾" x 10" 7" Round	YES
	EB36SS	36"						
	EB30WH	30"	Vertical 220 / 120	Vertical 5.5 / 1.4	White	2 - 500 Lumens, 6.5W LED, 3000K	¾" x 10" 7" Round	YES
	EB36WH	36"						
	EB30BL	30"	Vertical Round 230 / 130	Vertical Round 5.5 / 1.3	Black	2 - 500 Lumens, 6.5W LED, 3000K	¾" x 10" 7" Round	YES
	EB36BL	36"						
	AB30SS	30"	Horizontal 250	Horizontal 5.0	Stainless Steel	2 - 50W Halogen	¾" x 10" 7" Round	NO
	AB36SS	36"						
	AB30WH	30"	Vertical 220	Vertical 5.5	White	2 - 50W Halogen	¾" x 10" 7" Round	NO
	AB36WH	36"						
	AB30BL	30"	Vertical Round 230	Vertical Round 5.5	Black	2 - 50W Halogen	¾" x 10" 7" Round	NO
	AB36BL	36"						

### DIMENSIONS

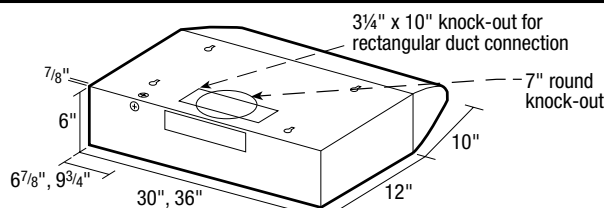

# Under Cabinet Range Hoods

## FEATURES

- **Quiet, energy efficient operation.**
- Three speed motor control  
(24" models and ADA models include 2 speed motor control).
- Included, easily removable aluminum grease filters capture grease and debris.
- **Included** 8 watt GU24 base LED lamp, **Complies with California Title 24 requirements.** Also features a 4 watt night light (bulb not included).
- Can be ducted either horizontally or vertically with the included duct collar and back draft damper (ducting available separately). Convertible to ductless operation with the addition of model CF-01 (30" and 36" models) or model CF-07 (24" models) charcoal odor filters (available separately).  
The ENERGY STAR Program for Residential Ventilating Fans has no provision for qualification of ductless range hoods (recirculating not ventilating), as a result the ENERGY STAR program applies to ducted range hoods only.
- **Suggested Accessories:** Back Splash, Roof or Wall Cap.



## AMERICANS WITH DISABILITIES ACT (ADA) Compliant models

- Included dual rocker, white control switch mounts to the wall at an accessible height. Fits a triple gang box.



## DELUXE QUIET RANGE HOODS

	MODEL	WIDTH	AIRFLOW (CFM)	SOUND (SONES)	FINISH	LIGHTING	DUCTING OPTIONS	ENERGY STAR® CERTIFIED		
	ESDQ1248	24"	Horizontal 270 / 150	Horizontal 4.0 / 1.5	Stainless Steel	675 Lumens, 8W LED, 4000K	3/4" x 10"	YES		
	ESDQ1308	30"								
	ESDQ1368	36"								
	ESDQ1243	24"			Vertical 270 / 150	Vertical 4.0 / 1.5	White	675 Lumens, 8W LED, 4000K	3/4" x 10"	YES
	ESDQ1303	30"								
	ESDQ1363	36"								
	ESDQ1246	24"	Horizontal 250 / 150	Horizontal 4.0 / 1.5			Black	675 Lumens, 8W LED, 4000K	3/4" x 10"	YES
	ESDQ1306	30"								
	ESDQ1366	36"								
	ES248ADA	24"			Horizontal 250 / 150	Horizontal 4.0 / 1.5	Stainless Steel	675 Lumens, 8W LED, 4000K	3/4" x 10"	YES
	ES308ADA	30"								
	ES368ADA	36"								
	ES243ADA	24"	Vertical 250 / 150	Vertical 4.0 / 1.5			White	675 Lumens, 8W LED, 4000K	3/4" x 10"	YES
	ES303ADA	30"								
	ES363ADA	36"								
	ES246ADA	24"			Horizontal 250 / 150	Horizontal 4.0 / 1.5	Black	675 Lumens, 8W LED, 4000K	3/4" x 10"	YES
	ES306ADA	30"								
	ES366ADA	36"								

## DIMENSIONS

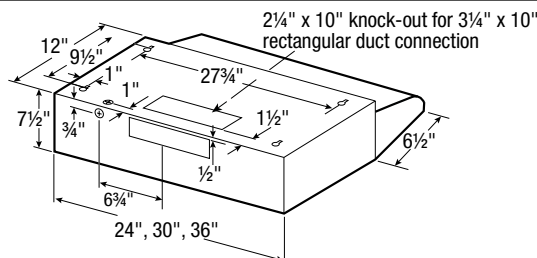

# Under Cabinet Range Hoods



## FEATURES

- **Quiet, energy efficient operation.**
- Two speed motor control.
- Included, easily removable aluminum grease filters capture grease and debris.
- **Included 6 watt GU24 base LED lamp, Complies with California Title 24 requirements.**
- Can be ducted either horizontally or vertically with the included duct collar and back draft damper for 3/4" x 10" ducting (ducting available separately). Convertible to 7" round vertical ducting with the addition of model ARD7R duct collar and damper (available separately). Convertible to ductless operation with the addition of a model CF-08 charcoal odor filter.







The ENERGY STAR Program for Residential Ventilating Fans has no provision for qualification of ductless range hoods (recirculating not ventilating), as a result the ENERGY STAR program applies to ducted range hoods only.

- **Suggested Accessories:** Back Splash, Roof or Wall Cap.

## AMERICANS WITH DISABILITIES ACT (ADA) Compliant models

- Included dual rocker, white control switch mounts to the wall at an accessible height. Fits a triple gang box.



QUIET ZONE RANGE HOODS									
	MODEL	WIDTH	AIRFLOW (CFM)	SOUND (SONES)	FINISH	LIGHTING	DUCTING OPTIONS	ADA COMPLIANT	ENERGY STAR® CERTIFIED
	ESQZ2308	30"	Horizontal 230 / 100	Horizontal 6.0 / 1.2	Stainless Steel	525 Lumens, 6W LED, 4000K	3/4" x 10", 7" round	NO	YES
	ESQZ2368	36"							
	ESQZ2303	30"	Vertical 210 / 120	Vertical 5.0 / 1.5	White	525 Lumens, 6W LED, 4000K	3/4" x 10", 7" round	NO	YES
	ESQZ2363	36"							
	ESQZ2306	30"	Round 200 / 110	Round 5.5 / 1.5	Black	525 Lumens, 6W LED, 4000K	3/4" x 10", 7" round	NO	YES
	ESQZ2366	36"							
	ESZ308ADA	30"	Horizontal 230 / 100	Horizontal 6.0 / 1.2	Stainless Steel	525 Lumens, 6W LED, 4000K	3/4" x 10", 7" round	YES	YES
	ESZ368ADA	36"							
	ESZ303ADA	30"	Vertical 210 / 120	Vertical 5.0 / 1.5	White	525 Lumens, 6W LED, 4000K	3/4" x 10", 7" round	YES	YES
	ESZ363ADA	36"							
	ESZ306ADA	30"	Round 200 / 110	Round 5.5 / 1.5	Black	525 Lumens, 6W LED, 4000K	3/4" x 10", 7" round	YES	YES
	ESZ366ADA	36"							

## DIMENSIONS

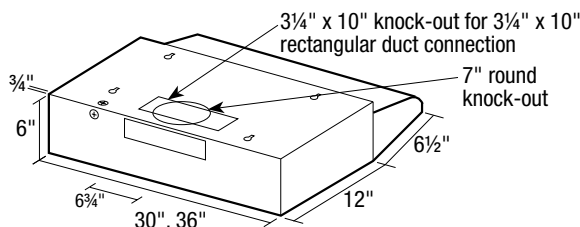



# Under Cabinet Range Hoods



## FEATURES

- Infinite speed motor control.
- Up to 200 CFM of ventilation.
- Included, easily removable aluminum mesh grease filter captures grease and debris.
- Utilizes a 26W medium base energy efficient fluorescent lamp (up to a 60W type A19 incandescent bulb can also be used).
- Can be ducted either horizontally or vertically with the included duct collar and back draft damper for 3/4" x 10" ducting (ducting available separately). Convertible to 7" round vertical ducting with the addition of model ARD7R duct collar and damper (available separately). Convertible to ductless operation with the addition of a model CF-08 charcoal odor filter.
- **Suggested Accessories:** Back Splash, Roof or Wall Cap.



## QUIET ZONE & DESIGNER SERIES RANGE HOODS

	MODEL	WIDTH	AIRFLOW (CFM)	SOUND (SONES)	FINISH	LIGHTING	DUCTING OPTIONS
	QZ2308	30"	Vertical 260	Vertical 6.0	Stainless Steel	26W CFL or 60W Incandescent (Bulb not included)	3/4" x 10", 7" Round
	QZ2368	36"					
	QZ2303	30"	Horizontal 250	Horizontal 5.5	White	26W CFL or 60W Incandescent (Bulb not included)	3/4" x 10", 7" Round
	QZ2363	36"					
	QZ2306	30"	Horizontal 250	Horizontal 5.5	Black	26W CFL or 60W Incandescent (Bulb not included)	3/4" x 10", 7" Round
	QZ2366	36"					
	DS1308	30"	Vertical 200	Vertical 6.5	Stainless Steel	26W CFL or 60W Incandescent (Bulb not included)	3/4" x 10", 7" Round
	DS1368	36"					
	DS1303	30"	Horizontal 200	Horizontal 6.5	White	26W CFL or 60W Incandescent (Bulb not included)	3/4" x 10", 7" Round
	DS1363	36"					
	DS1306	30"	Horizontal 200	Horizontal 6.5	Black	26W CFL or 60W Incandescent (Bulb not included)	3/4" x 10", 7" Round
	DS1366	36"					

### DIMENSIONS

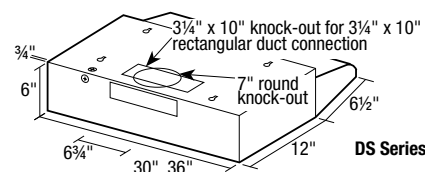
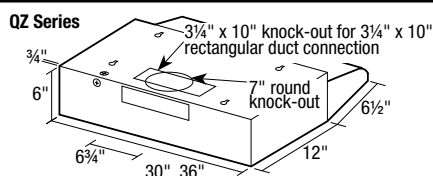

# Under Cabinet Range Hoods







## FEATURES

- Two speed motor control.
- Included, easily removable aluminum mesh grease filter captures grease and debris.
- Can be ducted either horizontally or vertically with the included duct collar and back draft damper for 3/4" x 10" ducting (ducting available separately). Convertible to 7" round vertical ducting with the addition of model ARD7R duct collar and damper (available separately). Convertible to ductless operation with the addition of a model RF-34S charcoal odor filter.
- Utilizes a 26W medium base energy efficient fluorescent lamp (up to a 60W type A19 incandescent bulb can also be used).
- **Suggested Accessories:** Back Splash, Roof or Wall Cap.



## ADVANTAGE SERIES RANGE HOODS

	MODEL	WIDTH	AIRFLOW (CFM)	SOUND (SONES)	FINISH	LIGHTING	DUCTING OPTIONS
	AV1218	21"	Vertical 180	Vertical 7.5	Stainless Steel	26W CFL or 60W Incandescent (Bulb not included)	3/4" x 10", 7" Round
	AV1248	24"					
	AV1308	30"	Horizontal 180	Horizontal 7.0			
	AV1368	36"					
	AV1428	42"					
	AV1213	21"	Vertical 180	Vertical 7.5	White	26W CFL or 60W Incandescent (Bulb not included)	3/4" x 10", 7" Round
	AV1243	24"					
	AV1303	30"	Horizontal 180	Horizontal 7.0			
	AV1363	36"					
	AV1214	21"	Vertical 180	Vertical 7.5	Biscuit	26W CFL or 60W Incandescent (Bulb not included)	3/4" x 10", 7" Round
	AV1244	24"					
	AV1304	30"	Horizontal 180	Horizontal 7.0			
	AV1364	36"					
	AV1424	42"					
	AV1215	21"	Vertical 180	Vertical 7.5	Almond	26W CFL or 60W Incandescent (Bulb not included)	3/4" x 10", 7" Round
	AV1245	24"					
	AV1305	30"	Horizontal 180	Horizontal 7.0			
	AV1365	36"					
	AV1425	42"					
	AV1216	21"	Vertical 180	Vertical 7.5	Black	26W CFL or 60W Incandescent (Bulb not included)	3/4" x 10", 7" Round
	AV1246	24"					
	AV1306	30"	Horizontal 180	Horizontal 7.0			
	AV1366	36"					
	AV1426	42"					

### DIMENSIONS

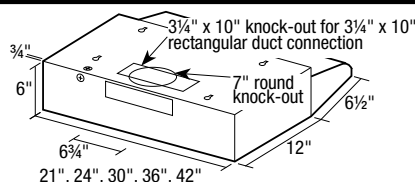

# Under Cabinet Range Hoods



## FEATURES





- Two speed motor control.
- Included, easily removable aluminum mesh grease filter captures grease and debris.
- Utilizes a 26W medium base energy efficient fluorescent lamp (up to a 60W type A19 incandescent bulb can also be used).
- **Suggested Accessories:** Back Splash, Roof or Wall Cap (for use with all series), ARD7R backdraft damper (for use with AR series only).

**AR SERIES:** Performance - 180 CFM @ 7.5 Sones Vertical, Filters: Grease - RF35S

**AX SERIES:** Performance - 160 CFM @ 6.5 Sones Horizontal/Vertical, Filters: Grease - RF35S

**AD SERIES:** Ductless Operation Only, Filters: Combination Odor/Grease - RF55

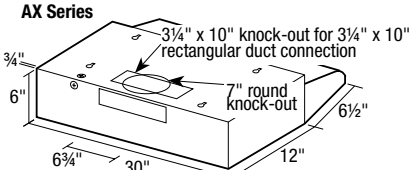
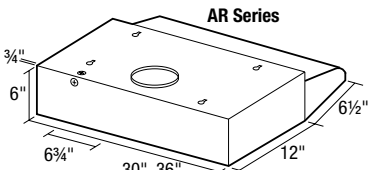
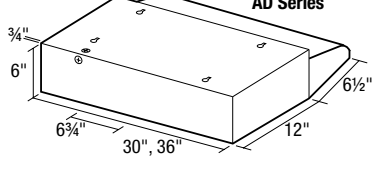

ADVANTAGE SERIES RANGE HOODS							
	MODEL	WIDTH	AIRFLOW (CFM)	SOUND (SONES)	FINISH	LIGHTING	DUCTING OPTIONS
	AR1308	30"	Vertical 180	Vertical 7.5	Stainless Steel	26W CFL or 60W Incandescent (Bulb not included)	7" Round
	AR1368	36"					
	AR1303	30"					
	AR1363	36"					
	AR1306	30"					
	AR1366	36"					
	AX1308	30"	Vertical 160	Vertical 6.5	Stainless Steel	26W CFL or 60W Incandescent (Bulb not included)	3 1/4" x 10" 7" Round
	AX1303	30"	Horizontal 160	Horizontal 6.5	White		
	AX1306	30"		Black			
	AD1308	30"	The Home Ventilating Institute (HVI) does not currently certify or test ductless range hoods. As a result, sound (sones) and CFM are not listed		Stainless Steel	26W CFL or 60W Incandescent (Bulb not included)	Ductless
	AD1368	36"					
	AD1303	30"					
	AD1363	36"					
	AD1306	30"					
	AD1366	36"					
<b>DIMENSIONS</b>							
 <p><b>AX Series</b></p>			 <p><b>AR Series</b></p>			 <p><b>AD Series</b></p>	

# Accessories

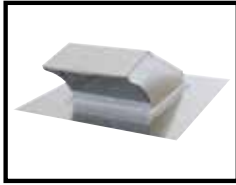

PRC Series

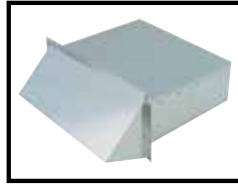

WCR10

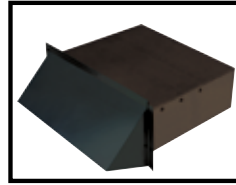

WC310B



PWC Series

## ROOF and WALL CAPS

The finishing touch to any system is the wall or roof cap. Properly exhaust the air out of the home using a roof or wall cap matched to your system's needs.

MODEL	DESCRIPTION	SIZE	CONSTRUCTION
PRC6R	Roof Cap w/ Damper	6" Round	Galvanized Steel
PRC8R	Roof Cap	8" Round	Galvanized Steel
PRC10R	Roof Cap w/ Damper	10" Round	Galvanized Steel
WCR10	Wall Cap	3¼" x 10"	Galvanized Steel
WC310B	Wall Cap w/Damper, Black	3¼" x 10"	Painted Steel
PWC6R	Wall Cap w/Damper	6" Round	Galvanized Steel
PWC8R	Wall Cap w/Damper	8" Round	Galvanized Steel
PWC10R	Wall Cap w/Damper	10" Round	Galvanized Steel



RSD24-10



EL907

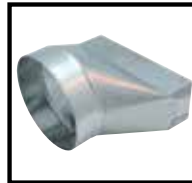

TR7-10



ARD7R



OA6V Series

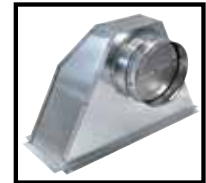

OA8V Series

## DUCTING ACCESSORIES

Properly connect your ducting using the Air King ducting accessories.

MODEL	DESCRIPTION	SIZE	CONSTRUCTION
RSD24-10	2' Ducting Section	3¼" x 10"	Galvanized Steel
EL907	90° Adjustable Elbow	7" Round	Galvanized Steel
TR7-10	Universal Boot Transition	3¼" x 10" - 7" Round	Galvanized Steel
RDC7	Round Collar (use with QZ, DS, and AV Series)	7" Round	Galvanized Steel
ARD7R	Round Collar w/Aluminum Damper (use with AR, QZ, DS, and AV Series)	7" Round	Galvanized Steel
OA6VD	Vertical Outlet Adapter w/Back Draft Damper <sup>2</sup>	6" Round	Galvanized Steel
OA8VD	Vertical Outlet Adapter w/Back Draft Damper <sup>2</sup>	8" Round	Galvanized Steel
OA10V	Vertical Outlet Adapter	10" Round	Galvanized Steel
OA10VD	Vertical Outlet Adapter w/Back Draft Damper <sup>2</sup>	10" Round	Galvanized Steel
OA6HD	Vertical Outlet Adapter w/Back Draft Damper <sup>2</sup>	6" Round	Galvanized Steel
OA8HD	Horizontal Outlet Adapter w/Back Draft Damper <sup>2</sup>	8" Round	Galvanized Steel
OA10HD	Horizontal Outlet Adapter w/Back Draft Damper <sup>2</sup>	10" Round	Galvanized Steel

<sup>2</sup> For use with Professional Range Hood Series

## BARCELONA® COLLECTION SPICE RACKS

Enhance the functionality of the Valencia™ or Granada™ Series range hoods with the



addition of a spice rack. Rack easily installs to wall with included brackets.

MODEL	DESCRIPTION	SIZE	USE WITH
WSV30	Spice Rack	30"	Valencia™, Granada™
WSV36	Spice Rack	36"	Valencia™, Granada™



## FILTERS

Properly maintain your Air King range hood with the correct filter.

MODEL	DESCRIPTION	USE WITH
RF34S	Charcoal Odor Filter	DS, AV Series
RF35S	Grease Filter	DS, AV, AR Series
RF55S	Combination Grease/Charcoal Odor Filter	AD Series
CF-01S	Combination Grease/Charcoal Odor Filter	ESAP, ESDQ, ESADA Series
GF-01S	Grease Filter	ESAP, ESDQ, ESADA, ECV, ECQ Series
CF-07S	Combination Grease/Charcoal Odor Filter	ESDQ24, ES24ADA Series
GF-07S	Grease Filter	ESDQ24, ES24ADA, ECQ24 Series
CF-06S	Charcoal Odor Filter	QZ2 Series
GF-06S	Grease Filter	QZ2 Series
CF-08	Charcoal Odor Filter	ESQZ Series
GF-08	Grease Filter	ESQZ Series
CF-09	Charcoal Odor Filter	30" AB, EB Series
GF-09	Grease Filter	30" AB, EB Series
CF-10	Charcoal Odor Filter	36" AB, EB Series
GF-10	Grease Filter	36" AB, EB Series
BCCF-01	Charcoal Odor Filter	Barcelona® Collection <sup>3</sup>
BCCF-02	Combination Grease/Charcoal Odor Filter	ESVAL, VAL Series
BCCF-03	Combination Grease/Charcoal Odor Filter	ESSEV, SEV Series
BCGF-01	Grease Filter	Barcelona® Collection
PGB-01	Grease Baffle	Professional Series
PGB-02	Grease Baffle	Professional Series
PGB-03	Grease Baffle	Professional Series
GF1030	Grease Filter	AP1030
GF1036	Grease Filter	AP1036
GF1830	Grease Filter	AP1830
GF1836	Grease Filter	AP1836
AP1830BK	Grease Baffle Kit	AP 30" Series
AP1836BK	Grease Baffle Kit	AP 36" Series

<sup>3</sup> Except ESVAL and VAL series hoods

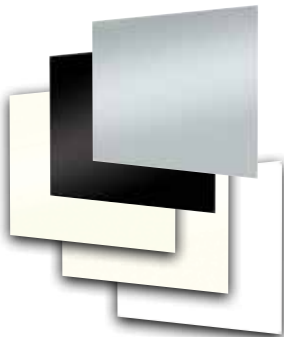

## UNDER CABINET BACK SPLASHES

Protect the wall behind your cooking surface with an Air King back splash, designed to match both the finish and size of your range hood.

WIDTH	HEIGHT	WHITE	BISCUIT	ALMOND	BLACK	STAINLESS STEEL
24"	24"	SP2424W	SP2424BI	SP2424A	SP2424B	SP2424S
30"	24"	SP2430W	SP2430BI	SP2430A	SP2430B	SP2430S
36"	24"	SP2436W	SP2436BI	SP2436A	SP2436B	SP2436S
42"	24"	SP2442W	SP2442BI	SP2442A	SP2442B	SP2442S

## RANGE HOOD SHELLS

The Air King range hood shells provide protection to the underside of the cabinets above the cooking surface when the area does not require ventilation. Includes the shell only.



WIDTH	WHITE	BISCUIT	ALMOND	BLACK	STAINLESS STEEL
21"	RS213	RS214	RS215	RS216	RS218
24"	RS243	RS244	RS245	RS246	RS248
30"	RS303	RS304	RS305	RS306	RS308
36"	RS363	RS364	RS365	RS366	RS368

NOTE: Models with a light function (RSL series) are available through special order.

## LED LAMPS

Illuminate the cooking surface with the lamps designed to work perfectly with your Air King ENERGY STAR® certified range hood.



MODEL	TYPE	USE WITH
AK8LED40	8 watt, LED GU24 base, 4000K ENERGY STAR qualified lamp	ESDQ, ESADA, ECQ Series
AK7LED30	6.5 watt, LED GU10 base, 3000K ENERGY STAR qualified lamp	ESVAL, ESSEV, LE, ESAPDQ, ECV, ESAPADA, EB Series
AK6LED40	6 watt, LED GU24 base, 4000K ENERGY STAR qualified lamp	ESQZ, ESZADA Series



# Specifications

MODEL	CFM/SONES <sup>4</sup>	FINISH	ENERGY STAR <sup>®</sup> CERTIFIED	PAGE
AP1030-600	600 / 5.5	Stainless Steel	NO	4
AP1036-600	600 / 5.5	Stainless Steel	NO	4
AP1830-600	600 / 5.5	Stainless Steel	NO	4
AP1836-600	600 / 5.5	Stainless Steel	NO	4
AP1030-500	500 / 4.5	Stainless Steel	NO	4
AP1036-500	500 / 4.5	Stainless Steel	NO	4
AP1830-500	500 / 4.5	Stainless Steel	NO	4
AP1836-500	500 / 4.5	Stainless Steel	NO	4
AP1836-900	900 / 11.0	Stainless Steel	NO	4
P1836m	*	Stainless Steel	NO	6
P1842m	*	Stainless Steel	NO	6
P1848m	*	Stainless Steel	NO	6
AP1836m	*	Stainless Steel	NO	6
P1030	*	Stainless Steel	NO	6
P1036	*	Stainless Steel	NO	6
P1036W	*	Stainless Steel	NO	6
P1836	*	Stainless Steel	NO	6
P1842	*	Stainless Steel	NO	6
P1848	*	Stainless Steel	NO	6
P1836W	*	Stainless Steel	NO	6
P1842W	*	Stainless Steel	NO	6
P1848W	*	Stainless Steel	NO	6
PIN300m	300 / 4.5	Stainless Steel	NO	8
PIN400m	500 / 8.0	Stainless Steel	NO	8
PIN600m	600 / 5.5	Stainless Steel	NO	8
PIN900m	900 / 11.0	Stainless Steel	NO	8
PIN1200m	1200 / 15.0	Stainless Steel	NO	8
LIN28m-400	400 / 8.0	Stainless Steel	NO	9
LIN28md-400	400 / 8.0	Stainless Steel	NO	9
LIN28m-600	600 / 5.5	Stainless Steel	NO	9
LIN28md-600	600 / 5.5	Stainless Steel	NO	9
LIN34m-400	400 / 8.0	Stainless Steel	NO	9
LIN34md-400	400 / 8.0	Stainless Steel	NO	9
LIN34m-600	600 / 5.5	Stainless Steel	NO	9
LIN34md-600	600 / 5.5	Stainless Steel	NO	9
LIN40m-400	400 / 8.0	Stainless Steel	NO	9
LIN40md-400	400 / 8.0	Stainless Steel	NO	9
LIN40m-600	600 / 5.5	Stainless Steel	NO	9
LIN40md-600	600 / 5.5	Stainless Steel	NO	9
LIN46md-1200	1200 / 15.0	Stainless Steel	NO	9
LIN58md-1200	1200 / 15.0	Stainless Steel	NO	9
ESSEV28	300 / 4.5	Stainless Steel	YES	10
LE300	300 / 4.5	Stainless Steel	YES	10
L300	300 / 4.5	Stainless Steel	NO	10
LE600	600 / 4.0	Stainless Steel	YES	10
L600	600 / 4.0	Stainless Steel	NO	10
SEV24AB	300 / 4.5	Stainless Steel	NO	10
SEV24S	450 / 11.5	Stainless Steel	NO	10
SEV28AB	300 / 4.5	Stainless Steel	NO	10
SEV28S	500 / 11.5	Stainless Steel	NO	10
ESVAL30SS	300 / 4.5	Stainless Steel	YES	11
ESVAL36SS	300 / 4.5	Stainless Steel	YES	11

MODEL	CFM/SONES <sup>4</sup>	FINISH	ENERGY STAR <sup>®</sup> CERTIFIED	PAGE
ESVAL30WH	300 / 4.5	White	YES	11
ESVAL36WH	300 / 4.5	White	YES	11
ESVAL30BL	300 / 4.5	Black	YES	11
ESVAL36BL	300 / 4.5	Black	YES	11
VAL30SSAB	300 / 4.5	Stainless Steel	NO	11
VAL30SS	500 / 11.0	Stainless Steel	NO	11
VAL36SSAB	300 / 4.5	Stainless Steel	NO	11
VAL36SS	500 / 11.0	Stainless Steel	NO	11
VAL30WHAB	300 / 4.5	White	NO	11
VAL30WH	500 / 11.0	White	NO	11
VAL36WHAB	300 / 4.5	White	NO	11
VAL36WH	500 / 11.0	White	NO	11
VAL30BLAB	300 / 4.5	Black	NO	11
VAL30BL	500 / 11.0	Black	NO	11
VAL36BLAB	300 / 4.5	Black	NO	11
VAL36BL	500 / 11.0	Black	NO	11
SEG36SS	600 / 14.0	Stainless Steel	NO	12
ARA36GL	570 / 12.5	Stainless Steel	NO	12
GRAN30SS	600 / 14.0	Stainless Steel	NO	12
GRAN36SS	600 / 14.0	Stainless Steel	NO	12
GRAN48SS	600 / 14.0	Stainless Steel	NO	12
IBIZ36GL	570 / 12.5	Stainless Steel	NO	13
PAMP36SS	600 / 14.0	Stainless Steel	NO	13
MAL36SS	600 / 14.0	Stainless Steel	NO	13
ALI36SS	500 / 11.0	Stainless Steel	NO	13
ALI36WH	500 / 11.0	White	NO	13
ALI36BL	500 / 11.0	Black	NO	13
LE300A	300 / 4.5	Stainless Steel	YES	14
LE600A	600 / 4.0	Stainless Steel	YES	14
ECV308	250 / 4.0	Stainless Steel	YES	15
ECV368	250 / 4.0	Stainless Steel	YES	15
ECQ248	250 / 4.0	Stainless Steel	YES	16
ECQ308	250 / 4.0	Stainless Steel	YES	16
ECQ368	250 / 4.0	Stainless Steel	YES	16
ECQ243	250 / 4.0	White	YES	16
ECQ303	250 / 4.0	White	YES	16
ECQ363	250 / 4.0	White	YES	16
ECQ246	250 / 4.0	Black	YES	16
ECQ306	250 / 4.0	Black	YES	16
ECQ366	250 / 4.0	Black	YES	16
ESAPDQ30	270 / 4.0	Stainless Steel	YES	17
ESAPDQ36	270 / 4.0	Stainless Steel	YES	17
ESAP30ADA	270 / 4.0	Stainless Steel	YES	17
ESAP36ADA	270 / 4.0	Stainless Steel	YES	17
EB30SS	220 / 5.5	Stainless Steel	YES	18
EB36SS	220 / 5.5	Stainless Steel	YES	18
EB30WH	220 / 5.5	White	YES	18
EB36WH	220 / 5.5	White	YES	18
EB30BL	220 / 5.5	Black	YES	18
EB36BL	220 / 5.5	Black	YES	18
AB30SS	220 / 5.5	Stainless Steel	NO	18
AB36SS	220 / 5.5	Stainless Steel	NO	18
AB30WH	220 / 5.5	White	NO	18

<sup>4</sup> CFM/Sones on high speed with vertical discharge - see individual page for full specifications.  
\* Unit does not include blower (blower is sold separately)

# Specifications

MODEL	CFM/SONES <sup>4</sup>	FINISH	ENERGY STAR <sup>®</sup> CERTIFIED	PAGE
AB36WH	220 / 5.5	White	NO	18
AB30BL	220 / 5.5	Black	NO	18
AB36BL	220 / 5.5	Black	NO	18
ESDQ1248	270 / 4.0	Stainless Steel	YES	19
ESDQ1308	270 / 4.0	Stainless Steel	YES	19
ESDQ1368	270 / 4.0	Stainless Steel	YES	19
ESDQ1243	270 / 4.0	White	YES	19
ESDQ1303	270 / 4.0	White	YES	19
ESDQ1363	270 / 4.0	White	YES	19
ESDQ1246	270 / 4.0	Black	YES	19
ESDQ1306	270 / 4.0	Black	YES	19
ESDQ1366	270 / 4.0	Black	YES	19
ES248ADA	250 / 4.0	Stainless Steel	YES	19
ES308ADA	250 / 4.0	Stainless Steel	YES	19
ES368ADA	250 / 4.0	Stainless Steel	YES	19
ES243ADA	250 / 4.0	White	YES	19
ES303ADA	250 / 4.0	White	YES	19
ES363ADA	250 / 4.0	White	YES	19
ES246ADA	250 / 4.0	Black	YES	19
ES306ADA	250 / 4.0	Black	YES	19
ES366ADA	250 / 4.0	Black	YES	19
ESQZ2308	210 / 5.0	Stainless Steel	YES	20
ESQZ2368	210 / 5.0	Stainless Steel	YES	20
ESQZ2303	210 / 5.0	White	YES	20
ESQZ2363	210 / 5.0	White	YES	20
ESQZ2306	210 / 5.0	Black	YES	20
ESQZ2366	210 / 5.0	Black	YES	20
ESZ308ADA	210 / 5.0	Stainless Steel	YES	20
ESZ368ADA	210 / 5.0	Stainless Steel	YES	20
ESZ303ADA	210 / 5.0	White	YES	20
ESZ363ADA	210 / 5.0	White	YES	20
ESZ306ADA	210 / 5.0	Black	YES	20
ESZ366ADA	210 / 5.0	Black	YES	20
QZ2308	260 / 6.0	Stainless Steel	NO	21
QZ2368	260 / 6.0	Stainless Steel	NO	21
QZ2303	260 / 6.0	White	NO	21
QZ2363	260 / 6.0	White	NO	21
QZ2306	260 / 6.0	Black	NO	21
QZ2366	260 / 6.0	Black	NO	21
DS1308	200 / 6.5	Stainless Steel	NO	21
DS1368	200 / 6.5	Stainless Steel	NO	21
DS1303	200 / 6.5	White	NO	21
DS1363	200 / 6.5	White	NO	21
DS1306	200 / 6.5	Black	NO	21
DS1366	200 / 6.5	Black	NO	21
AV1213	180 / 7.5	White	NO	22
AV1243	180 / 7.5	White	NO	22
AV1303	180 / 7.5	White	NO	22
AV1363	180 / 7.5	White	NO	22
AV1423	180 / 7.5	White	NO	22

MODEL	CFM/SONES <sup>4</sup>	FINISH	ENERGY STAR <sup>®</sup> CERTIFIED	PAGE
AV1214	180 / 7.5	Biscuit	NO	22
AV1244	180 / 7.5	Biscuit	NO	22
AV1304	180 / 7.5	Biscuit	NO	22
AV1364	180 / 7.5	Biscuit	NO	22
AV1424	180 / 7.5	Biscuit	NO	22
AV1215	180 / 7.5	Almond	NO	22
AV1245	180 / 7.5	Almond	NO	22
AV1305	180 / 7.5	Almond	NO	22
AV1365	180 / 7.5	Almond	NO	22
AV1425	180 / 7.5	Almond	NO	22
AV1216	180 / 7.5	Black	NO	22
AV1246	180 / 7.5	Black	NO	22
AV1306	180 / 7.5	Black	NO	22
AV1366	180 / 7.5	Black	NO	22
AV1426	180 / 7.5	Black	NO	22
AV1218	180 / 7.5	Stainless Steel	NO	22
AV1248	180 / 7.5	Stainless Steel	NO	22
AV1308	180 / 7.5	Stainless Steel	NO	22
AV1368	180 / 7.5	Stainless Steel	NO	22
AV1428	180 / 7.5	Stainless Steel	NO	22
AR1303	180 / 7.5	White	NO	23
AR1363	180 / 7.5	White	NO	23
AR1308	180 / 7.5	Stainless Steel	NO	23
AR1368	180 / 7.5	Stainless Steel	NO	23
AX1303	160 / 6.5	White	NO	23
AX1306	160 / 6.5	Black	NO	23
AX1308	160 / 6.5	Stainless Steel	NO	23
AD1303	-	White	NO	23
AD1363	-	White	NO	23
AD1308	-	Stainless Steel	NO	23
AD1368	-	Stainless Steel	NO	23

**NOTE:** HVI does not currently certify or test ductless hoods. As a result, sound (sones) and CFM are not listed for the AD Series.

<sup>4</sup> CFM/Sones on high speed with vertical discharge - see individual page for full specifications.  
\* Unit does not include blower (blower is sold separately)



# TOTAL HOME VENTILATION

## CONTINUOUS VENTILATION



## OUTDOOR AIR



## KITCHEN VENTILATION



## BATHROOM VENTILATION



Products Featured In the 2017



with the Carey Brothers



Products Featured In

The **ABC GreenHome™ 3.0**



Products Featured In the

THE **NEW AMERICAN REMODELED HOME** 2017



## 4 TIME ENERGY STAR® PARTNER OF THE YEAR

2017, 2013 and 2012 Partner of the Year  
2014 Sustained Excellence & Climate Communications



Printed using low VOC inks on a composite of post consumer fiber, recycled paper and virgin pulp derived from sustainably managed forests.

