



JUMBO JOE® CHARCOAL GRILL

Read Owner's Guide before using the barbecue.

Lea la Guía del propietario antes de utilizar la barbacoa.

Lisez le guide d'utilisation avant d'utiliser le barbecue.



54774 07/20/12

Jumbo Joe® 03_15_2012

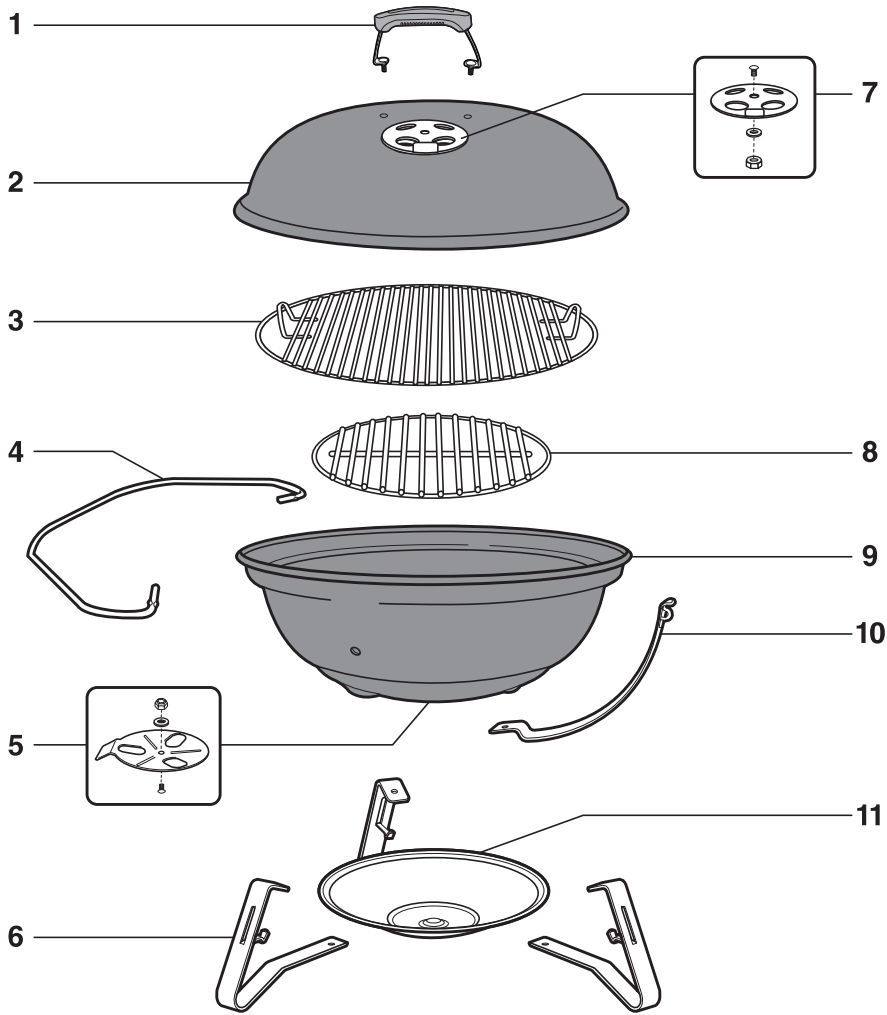

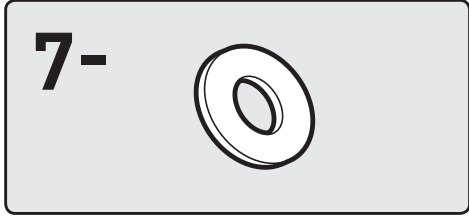
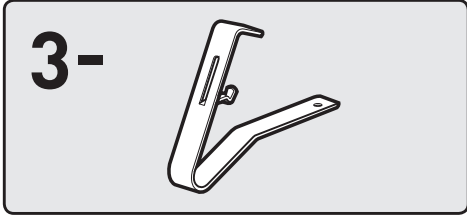
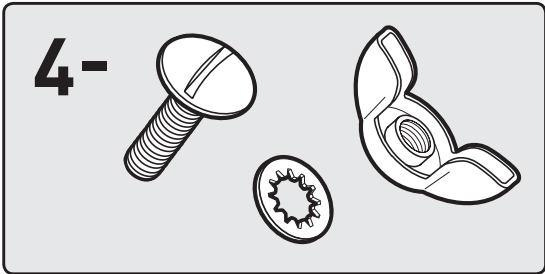
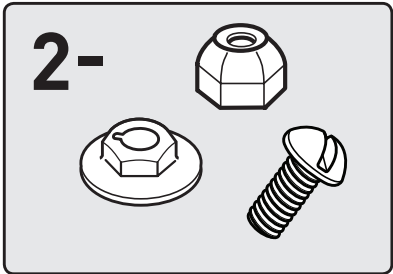
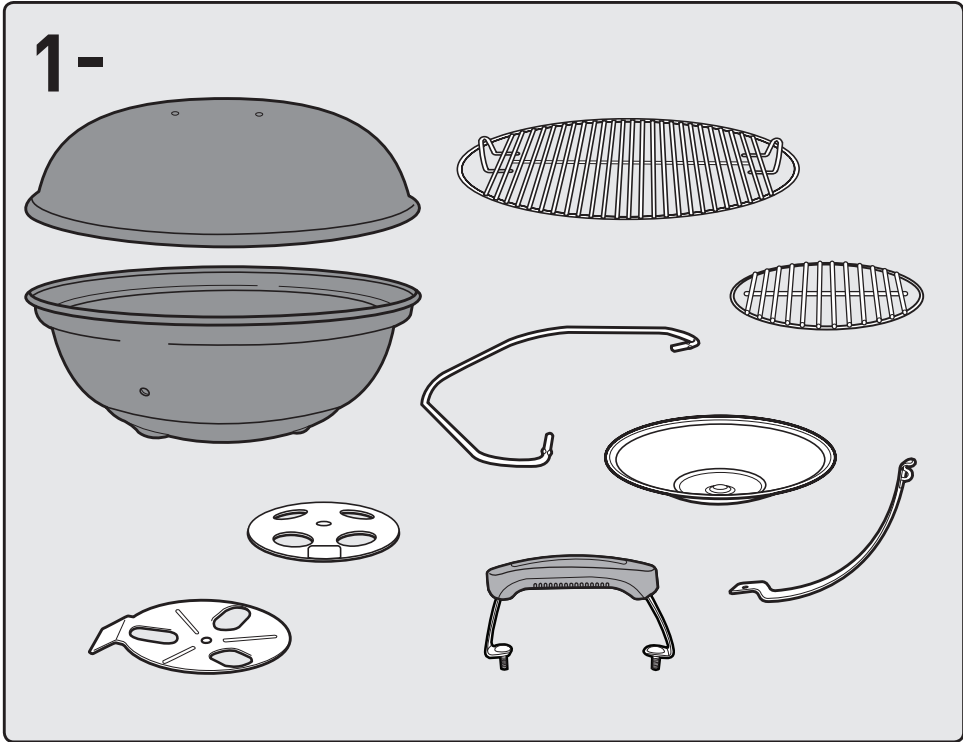

1

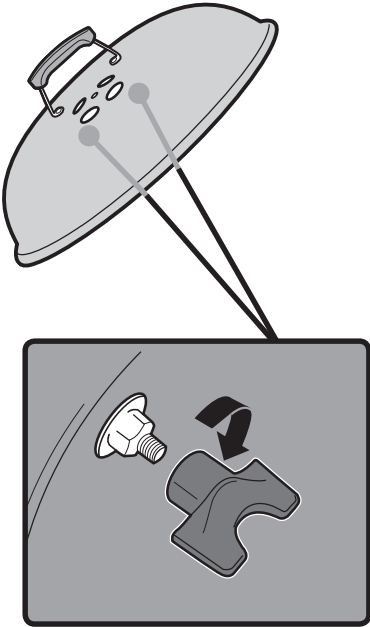
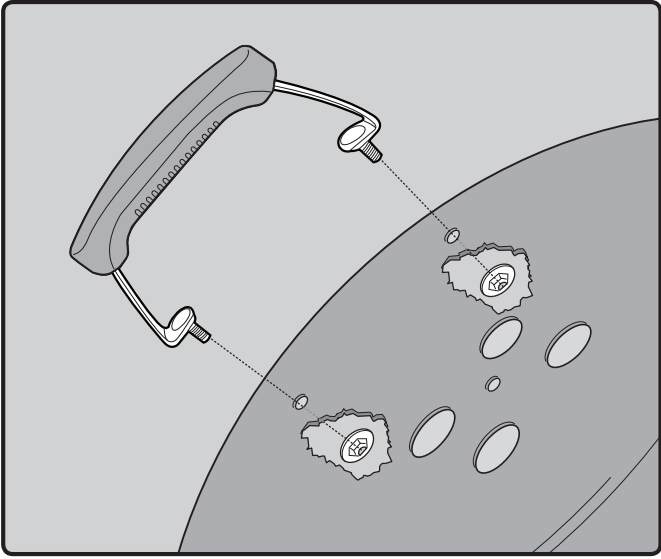

2

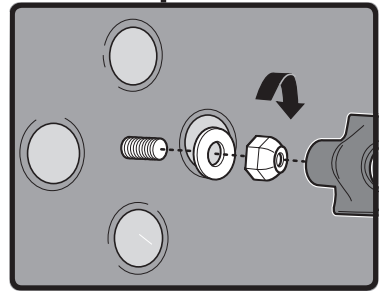
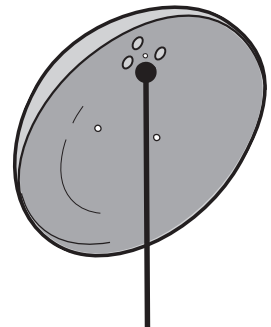
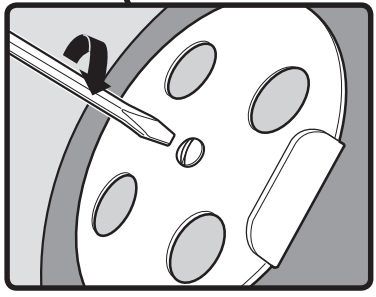
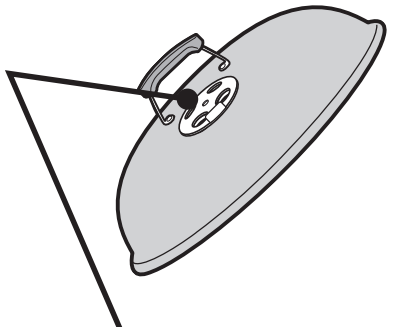
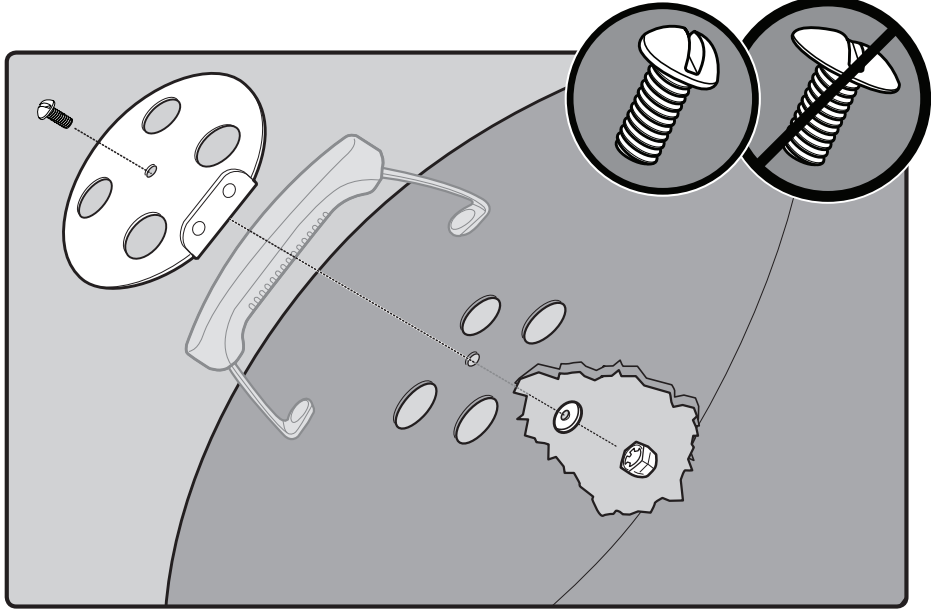
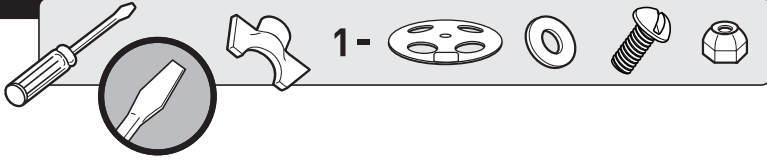

3

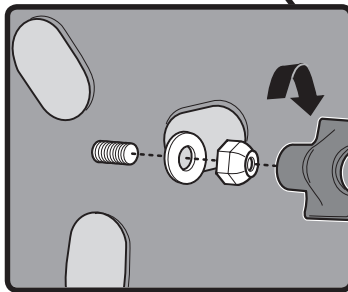
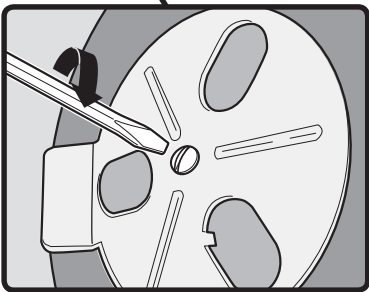
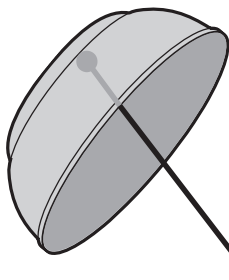
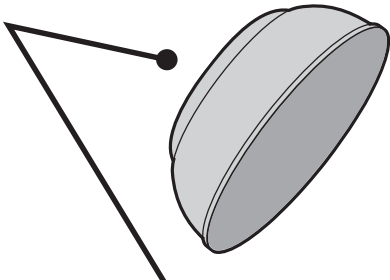
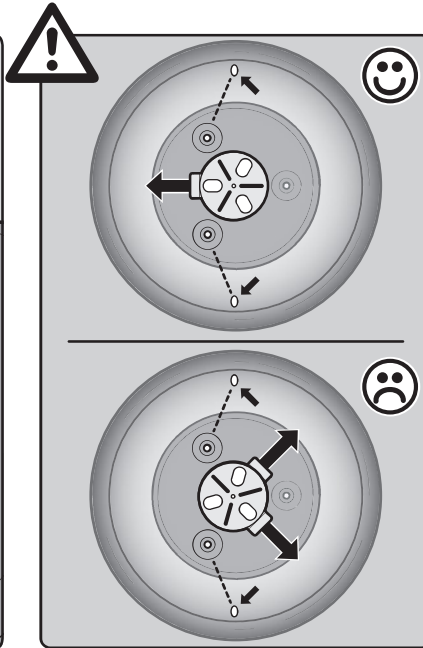
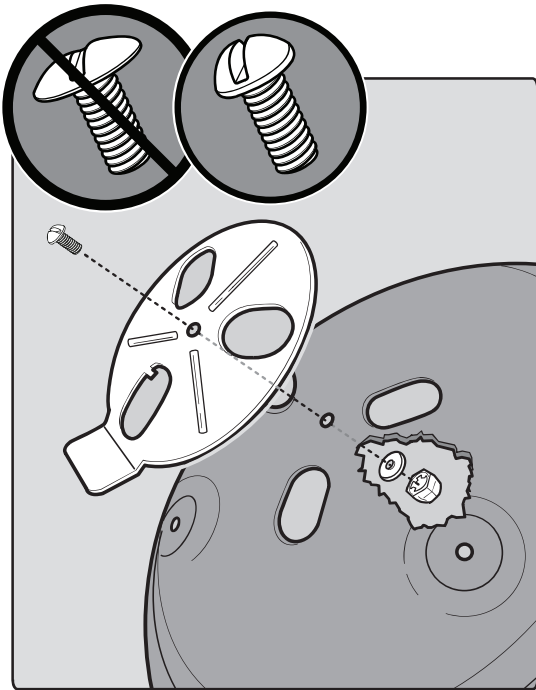
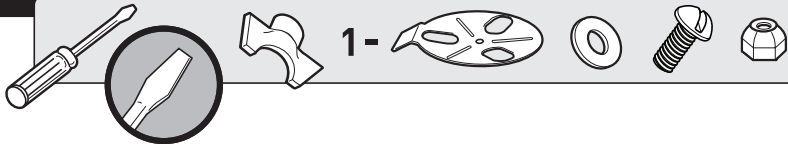

4

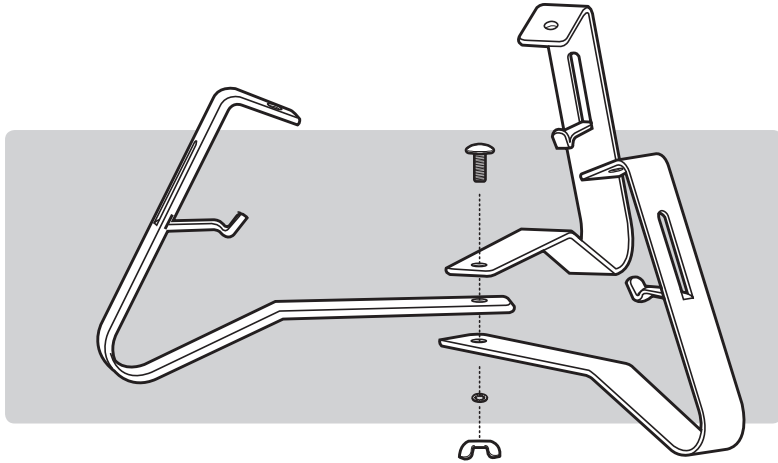
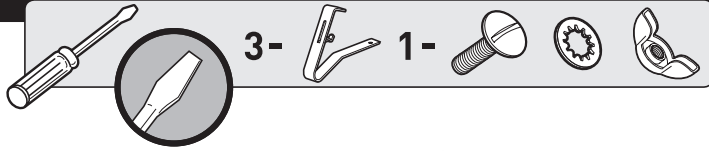

5

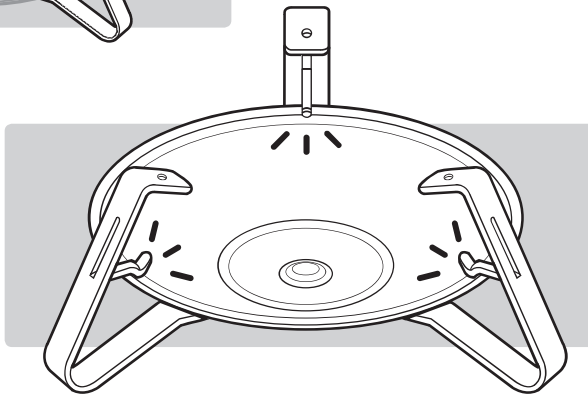
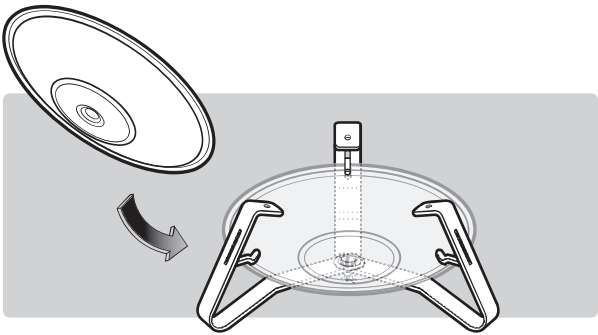

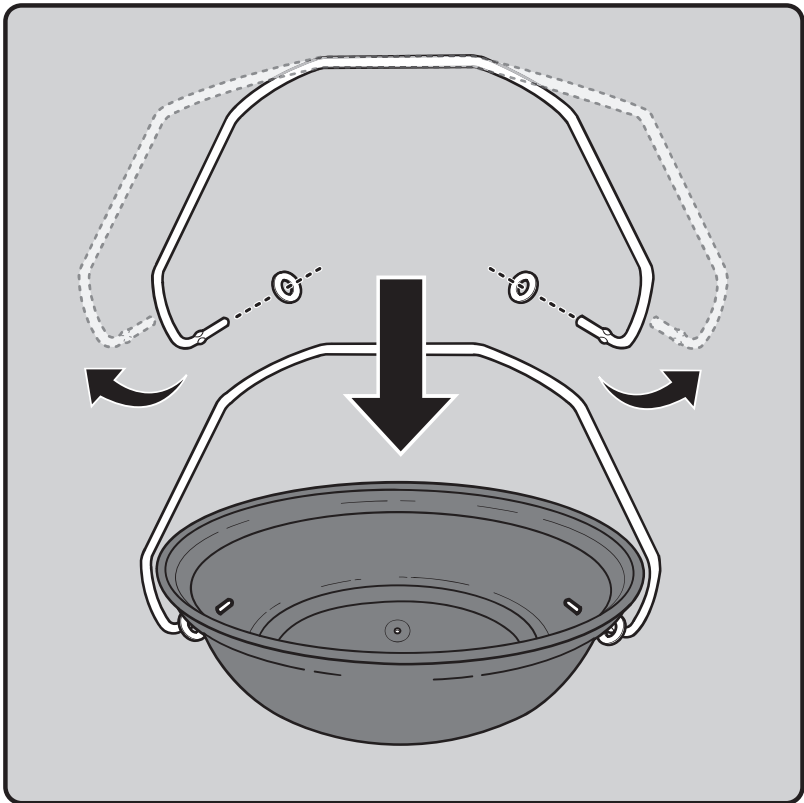

7

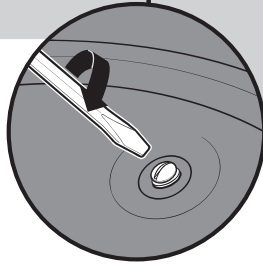
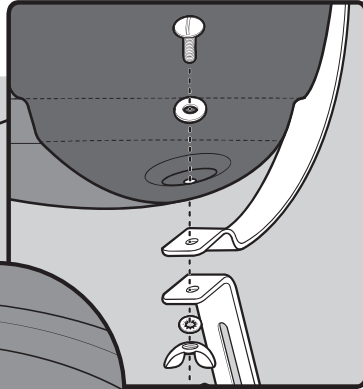
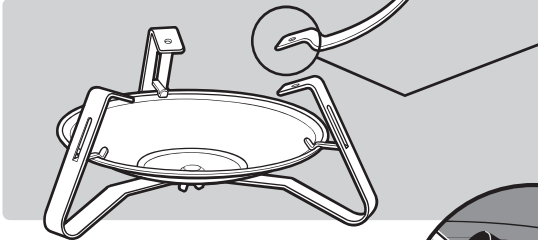
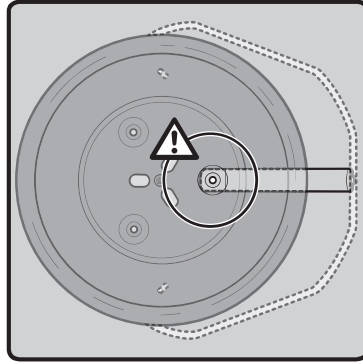
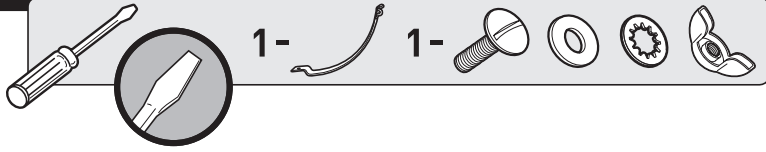

8

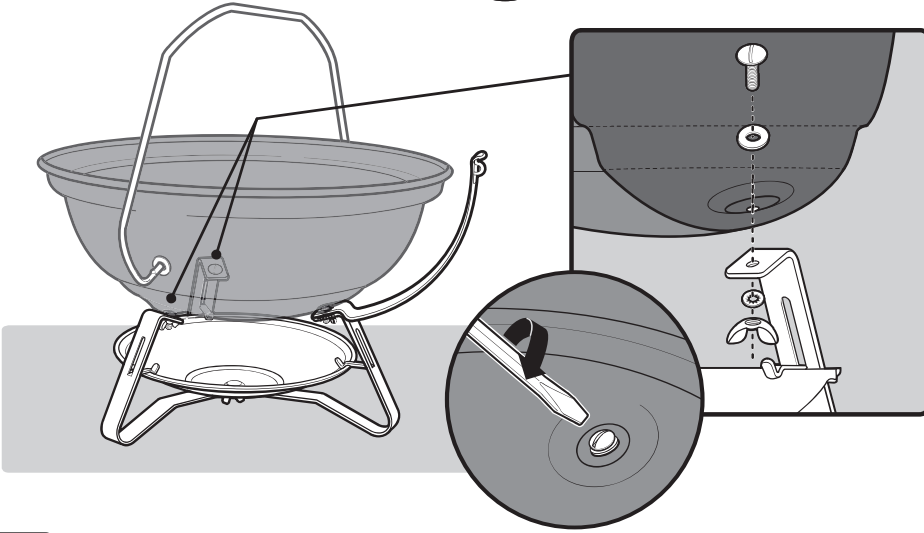
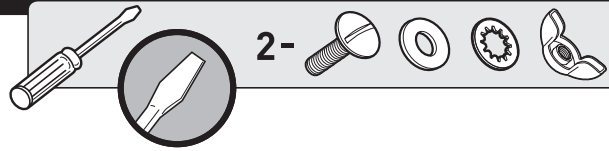

9

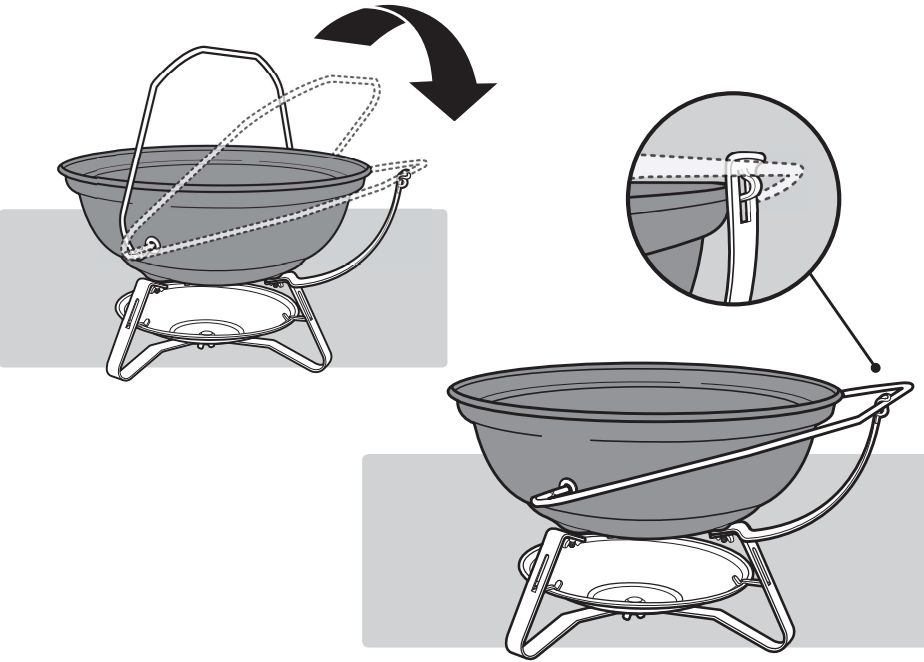

10

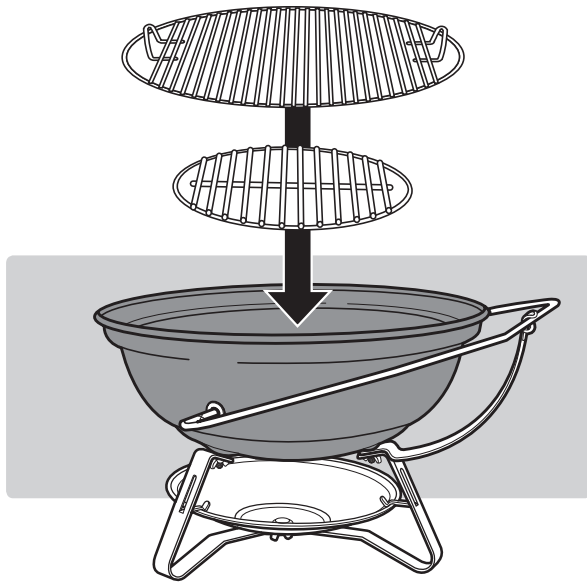

11

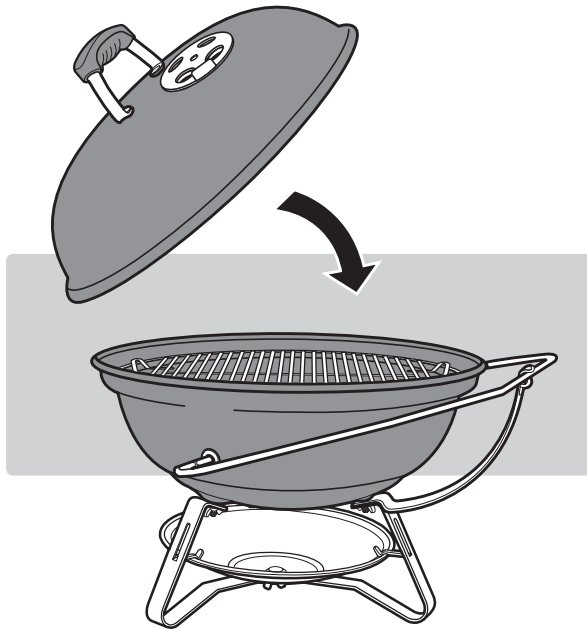

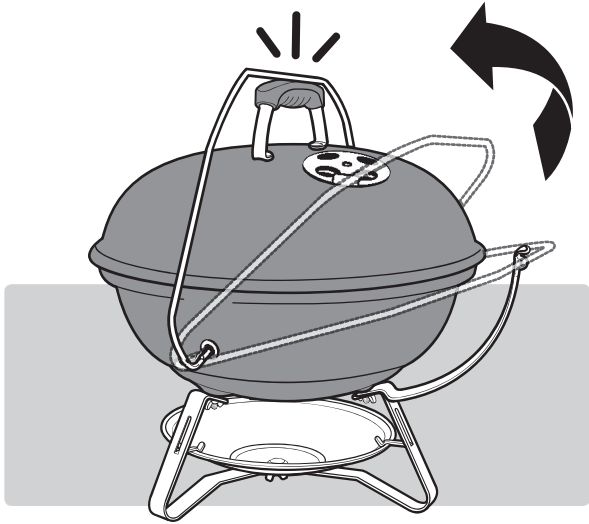

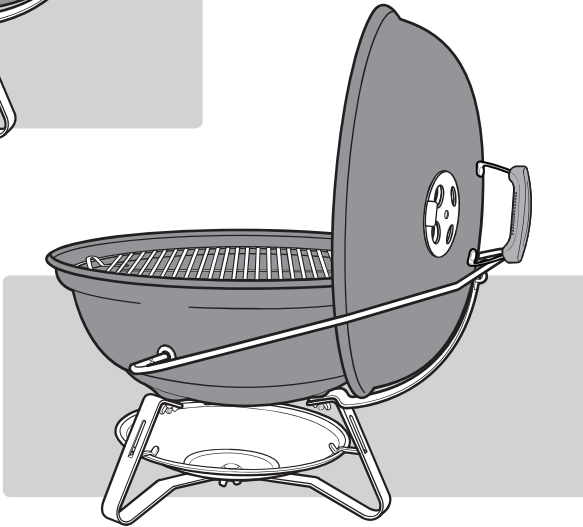
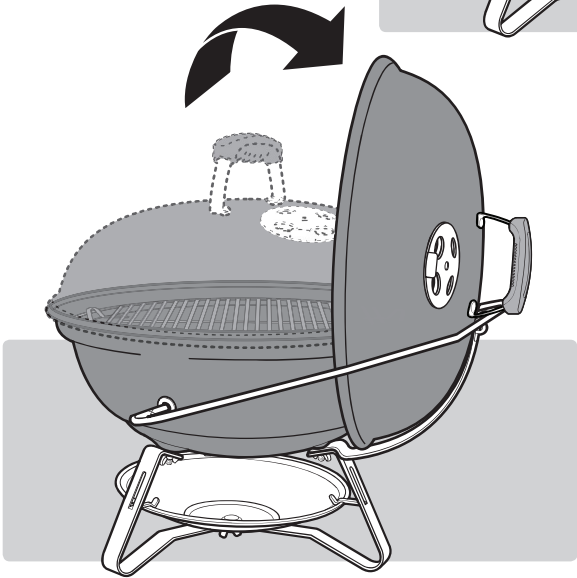
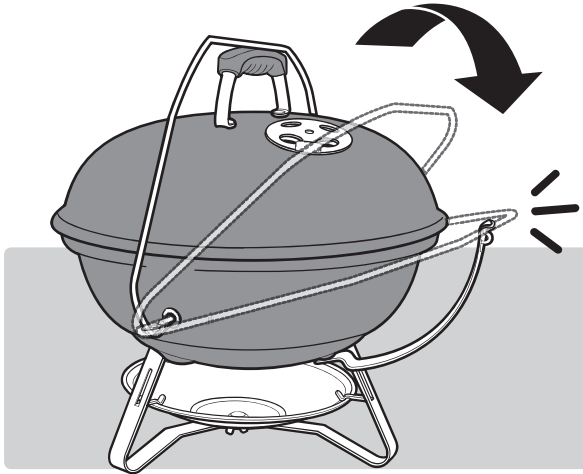

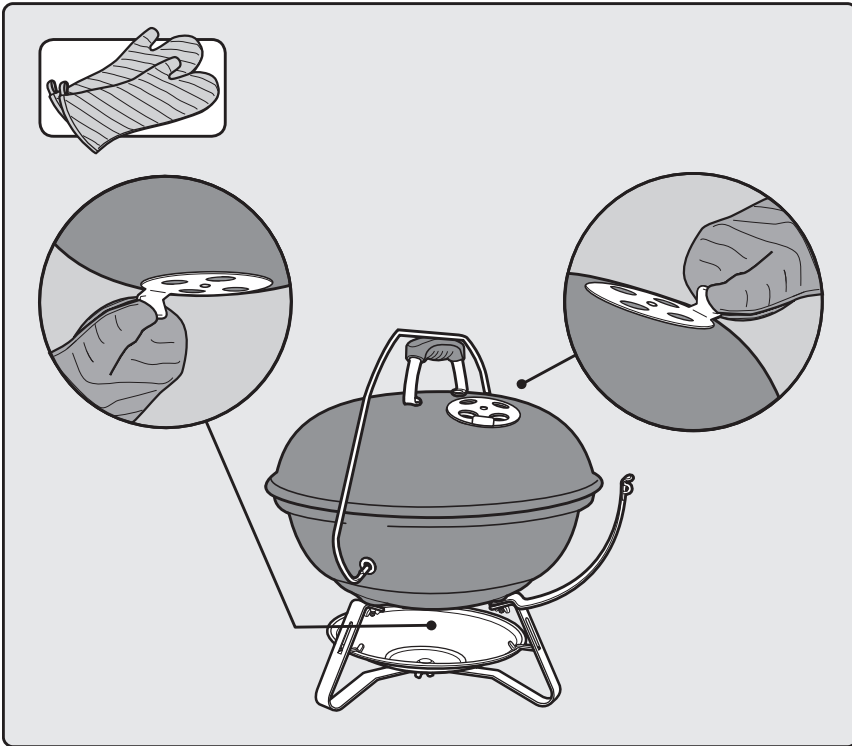



WEBER-STEPHEN PRODUCTS LLC
www.weber.com[®]

© 2012 Designed and engineered by Weber-Stephen Products LLC,
a Delaware limited liability company, located at 200 East Daniels Road, Palatine, Illinois 60067 U.S.A.
Printed in U.S.A.

© 2012 Diseñado por Weber-Stephen Products LLC,
una empresa de responsabilidad limitada de Delaware, ubicada en 200 East Daniels Road, Palatine, Illinois 60067 EE.UU.
Impreso en los EE.UU.

© 2012 Elaboré et conçu par Weber-Stephen Products LLC,
société à responsabilité limitée du Delaware, implantée au 200 East Daniels Road, Palatine, Illinois 60067 U.S.A.
Imprimé aux U.S.A.